



2010-01-01

Feasibility of Using Passive Monitoring Techniques in Mesh Networks for the Support of Routing

Chenzhe Zhang
Dublin Institute of Technology

Follow this and additional works at: <http://arrow.dit.ie/engmas>

 Part of the [Electrical and Computer Engineering Commons](#)

Recommended Citation

Zhang, C. (2010). *Feasibility of Using Passive Monitoring Techniques in Mesh Networks for the Support of Routing*. Masters dissertation. Dublin Institute of Technology. doi:10.21427/D7490J

This Theses, Masters is brought to you for free and open access by the Engineering at ARROW@DIT. It has been accepted for inclusion in Masters by an authorized administrator of ARROW@DIT. For more information, please contact yvonne.desmond@dit.ie, arrow.admin@dit.ie, brian.widdis@dit.ie.



This work is licensed under a [Creative Commons Attribution-NonCommercial-Share Alike 3.0 License](#)



Feasibility of Using Passive Monitoring Techniques in Mesh Networks for the Support of Routing

by

Chenzhe Zhang
BEng

A thesis submitted to the Dublin Institute of Technology
for the degree of

Master of Philosophy



Supervisor: Dr. Mark Davis

School of Electronic and Communications Engineering

2010

Abstract

In recent years, Wireless Mesh Networks (WMNs) have emerged as a promising solution to provide low cost access networks that extend Internet access and other networking services. Mesh routers form the backbone connectivity through cooperative routing in an often unstable wireless medium. Therefore, the techniques used to monitor and manage the performance of the wireless network are expected to play a significant role in providing the necessary performance metrics to help optimize the link performance in WMNs. This thesis initially presents an assessment of the correlation between passive monitoring and active probing techniques used for link performance measurement in single radio WMNs. The study reveals that by combining multiple performance metrics obtained by using passive monitoring, a high correlation with active probing can be achieved. The thesis then addresses the problem of the system performance degradation associated with simultaneous activation of multiple radios within a mesh node in a multi-radio environment. The experiments results suggest that the finite computing resource seems to be the limiting factor in the performance of a multi-radio mesh network. Having studied this characteristic of multi-radio networks, a similar approach as used in single radio mesh network analysis was taken to investigate the feasibility of passive monitoring in a multi-radio environment. The accuracy of the passive monitoring technique was compared with that of the active probing technique and the conclusion reached is that passive monitoring is a viable alternative to active probing technique in multi-radio mesh networks.

Declaration

I certify that this thesis which I now submit for examination for the award of _____, is entirely my own work and has not been taken from the work of others save and to the extent that such work has been cited and acknowledged within the text of my work.

This thesis was prepared according to the regulations for postgraduate study by research of the Dublin Institute of Technology and has not been submitted in whole or in part for an award in any other Institute or University.

The work reported on in this thesis conforms to the principles and requirements of the Institute's guidelines for ethics in research.

The Institute has permission to keep, to lend or to copy this thesis in whole or in part, on condition that any such use of the material of the thesis be duly acknowledged.

Signature_____Date_____

Acknowledgments

Firstly, I would like to thank my supervisor, Dr. Mark Davis, for all his support and availability to discuss all the issues that have arisen throughout these years at the Communication Network Research Institute (CNRI).

I am very grateful to all my colleagues at CNRI, without them it would not have been possible to complete my MPhil. In particular, I want to thank Mirek, Karol, Marak and Brian for all their help.

This research work has been funded by Science Foundation Ireland (SFI) under a Research Frontier Programme (RFP) award (reference number CMSF704). My thanks to this organization for making it possible for me to undertake this research work.

Finally I would also like to thank my family and friends for having stood by me and for their love and encouragement.

Table of Contents

Abstract.....	1
Table of Contents.....	1
List of Figures and Tables.....	3
Acronym	4
1 Introduction.....	6
2 Background Details.....	10
2.1 Wireless Mesh Networks Intro.....	10
2.2 Literature Review	12
2.2.1 The rise of wireless mesh networking	12
2.2.2 Performance measurement in wireless mesh networks	13
2.2.3 Why accurate link quality measurements?	17
2.2.4 Problems with performance measurements and existing techniques.....	19
2.2.5 Limitations of existing techniques	20
2.2.6 The study of multi-radio Mesh	23
2.2.7 The study of multi-hop wireless mesh.....	25
2.3 Summary	26
3 Technical Details	28
3.1 Introduction to CSMA/CA and passive metrics.....	28
3.1.1 CSMA/CA.....	28
3.1.2 Passive metrics.....	30
3.2 Single Radio Test bed	32
3.2.1 System description	33
3.2.2 Network setup and configuration.....	34
3.2.3 Experimental approach and evaluation metrics	35
3.3 Wireless Multi Radio Test bed.....	36
3.3.1 System Description	37
3.3.2 Network setup and configurations	37
3.3.3 Experimental approach and evaluation metrics	38
3.4 Cabled Multi Radio Test bed	40
3.4.1 System Description	41
3.4.2 Network setup and configurations	41
3.4.3 Experimental approach and evaluation metrics	42
4 Experimental Results	49
4.1 Single Radio Testbed	49

4.1.1	Correlation between the PER and the RSSI.....	49
4.1.2	Correlation between the PER and the idle bandwidth (BW_{idle}).....	50
4.1.3	Combining Passive Measurements	51
4.2	Wireless Multi Radio Testbed.....	53
4.2.1	Throughput statistics under non-saturation condition at the Tx node....	53
4.2.2	Throughput measurements under saturation condition at the Tx node..	56
4.2.3	Experiments at the Rx node	59
4.3	Cabled Multi Radio Testbed	61
4.3.1	Experiments to determine the weighting factors	61
4.4	Summary	67
5	Conclusions.....	69
5.1	Findings of this Work.....	70
5.2	Future Work	76
	References.....	79
	List of Publications	83

List of Figures and Tables

Figure 2.1	An illustration of a Wireless Mesh Network	11
Figure 2.2	Illustration of passive monitoring and active probing techniques.	15
Figure 3.1	MAC layer bandwidth components concept	31
Figure 3.2	Single radio experimental test bed.	34
Figure 3.3	Wireless multi-radio experimental test bed.	37
Figure 3.4	Cabled multi-radio experimental test bed.	41
Figure 3.5	Factors that have impact on PER.	44
Figure 4.1	Correlation coefficient of RSSI and PER over all test cases.	50
Figure 4.2	Correlation coefficient of BWide and PER over all test cases.	51
Figure 4.3	Correlation coefficient of the combined function and PER over all 30 test cases.	52
Figure 4.4	Variation in the combined function value and PER over time (Y-axis unit is percentage in true value).	53
Figure 4.5	The variation in the aggregate node throughput under non-saturation conditions with multiple wireless cards and different packet sizes.	54
Figure 4.6	Effect of additional NICs on throughput under non-saturation with a packet size of 1470 bytes.	55
Figure 4.7	Throughput statistics under saturation condition with reference to CPU idle% for a packet size of 1470 bytes .	57
Figure 4.8	Throughput comparison in 2 different modes under saturation @ 1470 bytes.	58
Figure 4.9	Plot of PER against Contention values.	63
Figure 4.10	Plot of PER against RSSI values.	63
Figure 4.11	Plot of PER against Line Rate values.	64
Figure 4.12	Pearson correlation coefficients over 40 test cases.	67
Table 3.1	Inter-dependencies of the passively gathered metrics.....	43
Table 3.2	Modulation schemes used for different LineRate s in 802.11a.....	46
Table 4.1	Throughput under non-saturation at the TX node with different packet sizes and number of active interfaces.	54
Table 4.2	Results recorded at the RX node under different test scenarios (link quality is obtained directly from the madwifi ifconfig command)	60
Table 4.3	Recorded values of PER when different metric combinations were used.	62
Table 4.4	The coefficients and the constant of the combined function model.	65
Table 4.5	The percentage error difference between the PER value predicted by the combined function model and the actual PER.	66

Acronym

AODV	Ad hoc On – Demand Distance Vector Routing Protocol
AWGN	Additive White Gaussian Noise
AP	Access Point
BAP	Broadcast based Active Probing
BC	Backoff Counter
BER	Bit Error Rate
BPSK	Binary Phase – Shift Keying
BW	Bandwidth
CA	Collision Avoidance
CCA	Clear Channel Assessment
CNRI	Communication Network Research Institute
CPU	Central Processing Unit
CSMA	Carrier Sense Multiple Access
CW	Contention Window
D-ITG	Distributed Internet Traffic Generator
DSR	Dynamic Source Routing
ETX	Expected Transmission Count
ETT	Expected Transmission Time
ExOR	Extremely Opportunistic Routing
ICMP	Internet Control Message Protocol
IEEE	Institute of Electrical and Electronics Engineers
IP	Internet Protocol
LOS	Line of Sight

MAC	Media Access Control
MASA	Multiple Access with Salvation Army
MN	Mesh Node
NADV	Normalized Advance (link metric)
NIC	Network Interface Card
PCI	Peripheral Component Interconnect
PER	Packet Error Rate
PHY	Physical Layer
QAM	Quadrature Amplitude Modulation
QoS	Quality of Service
QPSK	Quadrature Phase – Shift Keying
RF	Radio Frequency
RSSI	Received Signal Strength Indicator
Rx	Receiving
SIP	Session Initiation Protocol
SNR	Signal to Noise Ratio
SSH	Secure Shell
Tx	Transmitting
VoD	Video on Demand
VoIP	Voice/Video over IP
WLAN	Wireless Local Area Network
WEP	Wired Equivalent Privacy
WPA	Wi-Fi Protected Access
WRM	WLAN Resource Monitor
WMN	Wireless Mesh Network

1 Introduction

Next-generation wireless mobile communications will be driven by converged networks that integrate disparate technologies and services. Wireless Mesh Networks (WMNs) are expected to be one of the next generation of wireless interconnection technologies, providing flexible high bandwidth wireless backhaul over large geographical areas. While single radio mesh nodes operating on a single channel suffer from capacity constraints, equipping mesh routers with multiple radios using multiple non-overlapping channels can significantly alleviate the capacity problem and increase the aggregate bandwidth available to the network.

However, multi-radio WMNs face many limitations such as channel selection, routing, interference etc. Routing plays a critical role in improving the performance of WMNs. For the better support of routing, it is vital to have an effective mechanism of path selection and this process essentially involves assessing link performance and generating performance metrics to support the path selection mechanism.

Traditionally researchers have been using active probing methods to obtain such performance metrics. Although these active probing methods are considered to be accurate and efficient, they nevertheless impose an additional overhead on the network due to the extra probe packets transmitted on the medium,. This overhead poses a particular problem for WMNs due to the limited availability of bandwidth and the unpredictable nature of the medium. Furthermore, these additional probe

transmissions serve to increase the level of interference on the WMN which has the undesirable effect of further reducing the capacity.

Therefore obtaining accurate performance metrics with low overhead has always been a challenge for WMNs. The goal of this thesis is to present a feasible alternative to the active probing method in WMNs in order to avoid the overhead problem and increased interference.

The approach adopted here involves the development of a passive monitoring technique to estimate link performance metrics. The main advantage of passive monitoring when compared to active probing is that it passively listens to the transmissions on the medium and as such does not generate any overhead. Moreover, it does not lead to an increase in the level of interference in the wireless network environment.

Through a series of experiments conducted on single radio mesh nodes, it is shown that by combining several passively obtained performance metrics such as bandwidth availability, signal strength and contention, and it is possible to generate an accurate estimate of the packet error rate (*PER*) performance metric. In other words, we demonstrate the feasibility of using passive monitoring as a substitute for active probing on WMNs. A possible drawback of the passive monitoring approach is that it imposes an additional computational overhead on the mesh nodes (*MN*).

This thesis also undertook a study of the feasibility of passive monitoring in mesh networks. Multi-radio networks face many challenges such as channel assignment, mitigating interference etc. A major concern is the system performance degradation

associated with simultaneous activation of multiple radios within a node. Some researchers have ascribed this performance degradation to electrical and radio frequency (RF) crosstalk. Therefore, a first step in the study of multi-radio mesh networks was to verify the existence of this crosstalk and to investigate its impact on the performance of a network node. This involved the use of an experimental test bed where up to four radios were activated at a node. From the experimental results it was found that: i) the capacity of the network increases as the number of radios increases; ii) crosstalk does not appear to be a limiting factor in the performance of a multi-radio node, rather it is the limited computing resource available at the node that constrains the potential of multi-radio mesh networks.

To further verify these findings the test bed was modified by the introduction of couplers, antenna cables and attenuators to realize a cabled wireless network. This allows us to eliminate any potential external influences to the network as well as providing for controlled wireless environment. This allowed for greater reliability in the results gathered. Again, the experimental results from this cabled test bed confirmed the findings from the original wireless test bed.

The final step in the study of the feasibility of passive monitoring was to investigate its performance in a multi-radio mesh environment. A similar approach to that used for the single radio experiments was adopted where the accuracy of the passive monitoring was compared with that of active probing. Again, the results showed that it is possible to generate an accurate estimate of packet error rate (PER) performance metric through passive monitoring.

The final conclusion from this work is that passive motoring is a viable alternative to the active probing when seeking to estimate link performance metrics in a multi-radio mesh networks.

The rest of the thesis is organized as follows:

Chapter 2: Background Detail

This chapter provides the background to the study and underpins the various topics dealt with and the conclusions obtained.

Chapter 3: Technical Detail

This section describes the experimental test-bed set up which were used for the investigation of the performance of the passive monitoring technique. All the hardware used along with the protocols and network tools employed to conduct these experiments are presented in detail.

Chapter 4: Results

In this chapter the results obtained are presented along with the answers to a number of questions that arose over the course of the main experimental investigation.

Chapter 5: Summary and Conclusions

This chapter presents a summary of the main findings and conclusions arising from the experimental work carried out. It also suggests areas of further research.

2 Background Details

2.1 Wireless Mesh Networks Intro

In 1997, the Defense Advanced Research Projects Agency (DARPA), the organization that created the Internet, began developing a robust, tactical, mobile communications system for use by the U.S. Military. The military needed to provide soldiers with broadband access to IP-based voice, video and data services that could be used on the battlefield with little or no fixed infrastructure. The result was ad hoc peer-to-peer (p2p) wireless networking – more commonly known as mesh networking [49].

An ad hoc WMN is a collection of wireless terminals (e.g. handheld devices, mobile phones, automotive telematic systems, etc.) that communicate directly with each other without the aid of established infrastructure such as cell sites and towers. Through multi-hop routing techniques, the terminals act as routers/relays for each other and extend the range and coverage of communications links between users. The Figure 2.1 below is an illustration of a WMN.

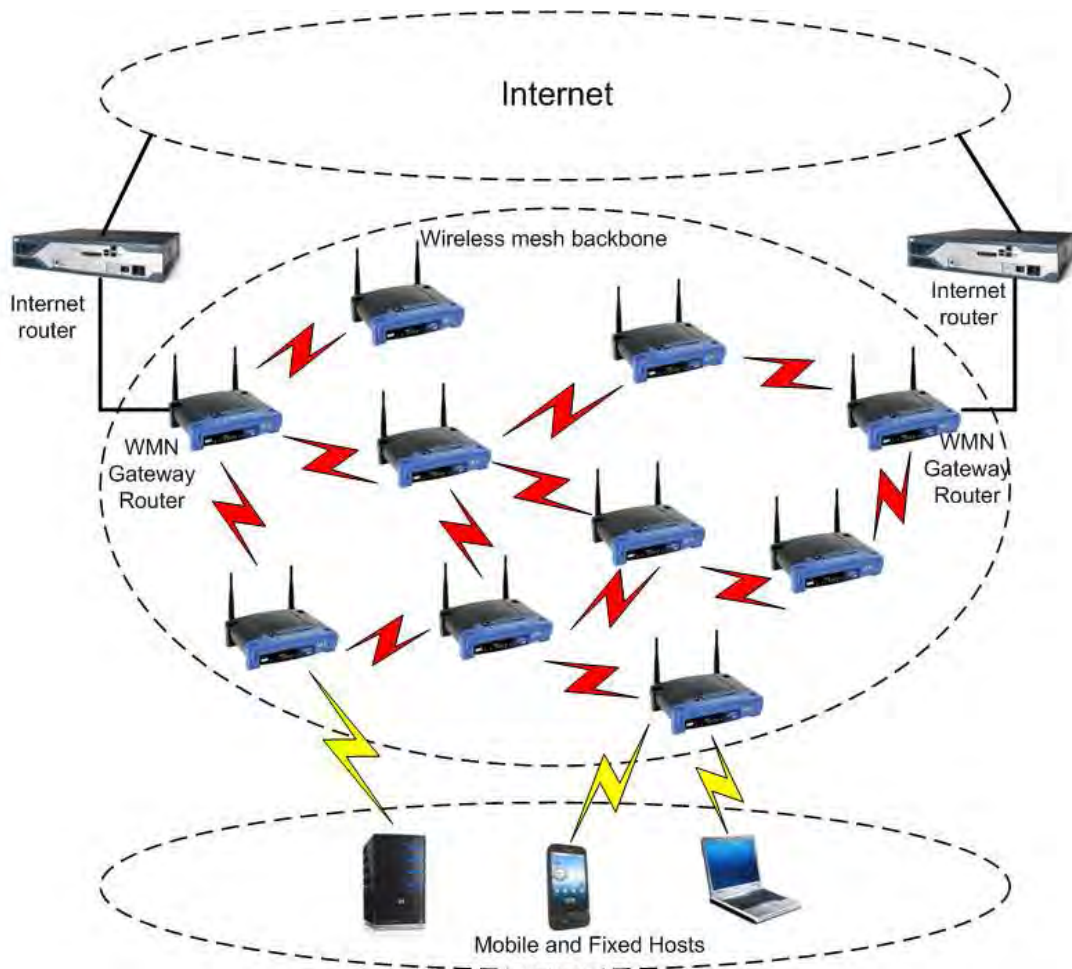

Figure 2.1: An illustration of a Wireless Mesh Network

Traditional mobile solutions attempt to create a mobile broadband data network by overlaying data onto a circuit-switched, voice-centric system. WMNs take a different approach by offering an end-to-end IP-based packet switched mesh architecture that closely mimics the wired Internet's architecture.

Wireless Mesh Networks' peer-to-peer routing technology is significant because as each node joins the network they also act as mobile routers and repeaters for every other device in the network. In short they are the network. Because users carry much of the network with them, network capacity and coverage is dynamically shifted to accommodate changing user patterns. As users congregate and create pockets of high

demand, they also create additional routes for each other to hop through, thus enabling network capacity from surrounding access points to be utilized. Intelligent routing technology allows users to automatically hop away from congested routes and access points to less congested routes and network access points. This permits the network to increase network utilization. This self-balancing aspect of the WMN architecture is one of its fundamental advantages over cellular wireless topologies, as cellular network usually adopts a single base station (AP) – end users scenario, so when the base station experience performance issue, there is no other paths available to re-route the packets in a given geographic location. The most attractive feature of WMN architecture is that it is a cost effective way to deploy large scale (and usually outdoor) wireless broadband access networks. But when compared to cellular topologies, a clear disadvantage of WMN is that the exchange of routing information can produce a lot of traffic overhead, i.e. every device on the network shall have an overview of all other routes and how to reach them.

2.2 Literature Review

2.2.1 The rise of wireless mesh networking

Infrastructure wireless networks based on the IEEE 802.11 protocol have become a popular choice as a network access technology. The fact that they require no wires thus allowing for increased mobility has led to their widespread acceptance in home and office environments. Within this context a wireless access point (AP) attaches a multitude of wireless devices to an infrastructure network through a single wired connection. Potential disadvantages of this configuration are i) each AP needs to

maintain at least one wired connection (i.e. the backhaul connection) which constitutes the most significant part of the network cost, and ii) the range of the access network is limited by the range of the wireless medium.

These limitations gave birth to a new area of wireless communication referred to as wireless mesh networking [1]. Wireless mesh networking has been drawing considerable attention due mainly to its potential for last-mile broadband services, instant surveillance systems, and back-haul services for large-scale wireless sensor networks [2], [3], [4], [5]. Within this area each AP no longer needs to maintain its own wired connection and may relay traffic generated by other APs. The benefits of the proposed solution are i) the network can now extend beyond the range of a single access point, and ii) the costly wired connection attaching the wireless network to the Internet now serves more traffic than that of a single AP [6], [7].

2.2.2 Performance measurement in wireless mesh networks

In order to optimize the link performance in WMNs, it is necessary to make use of performance metrics that take account of jitter, packet error rate, delay, capacity, bandwidth, etc. In this section the different aspects of performance measurements are discussed.

Wireless network performance measurements have been in use since the beginning of WLAN networking [8]. Their applications range from characterizing wireless networks and networking protocols, traffic or user patterns, detecting performance

anomalies, planning location of critical nodes, analyzing the performance of deployed services, determining service policies, etc. However, it has not been until recently that the need for wireless measurements has become important to network researchers and administrators as the number of wireless networking users and the demands for a more efficient management of resources grows.

There are generally two methods used in wireless network performance measurement: The active probing technique and the passive monitoring method. Active probing involves accessing the wireless network and broadcasting probe packets. It has the disadvantage that it generates a transmission overhead which reduces the capacity of the network. On the other hand, passive monitoring is a technique whereby all network transmissions are passively intercepted and subsequent processing produces the performance metrics. It has the advantage that it does not generate an overhead. See the Figure 2.2 for an illustration of overhead associated with passive and active probing techniques. As the node density increases, the path selection becomes more complex, and each path needs to be probed for accurate link quality for the support of routing, thus the overhead associated with active probing method increases as well.

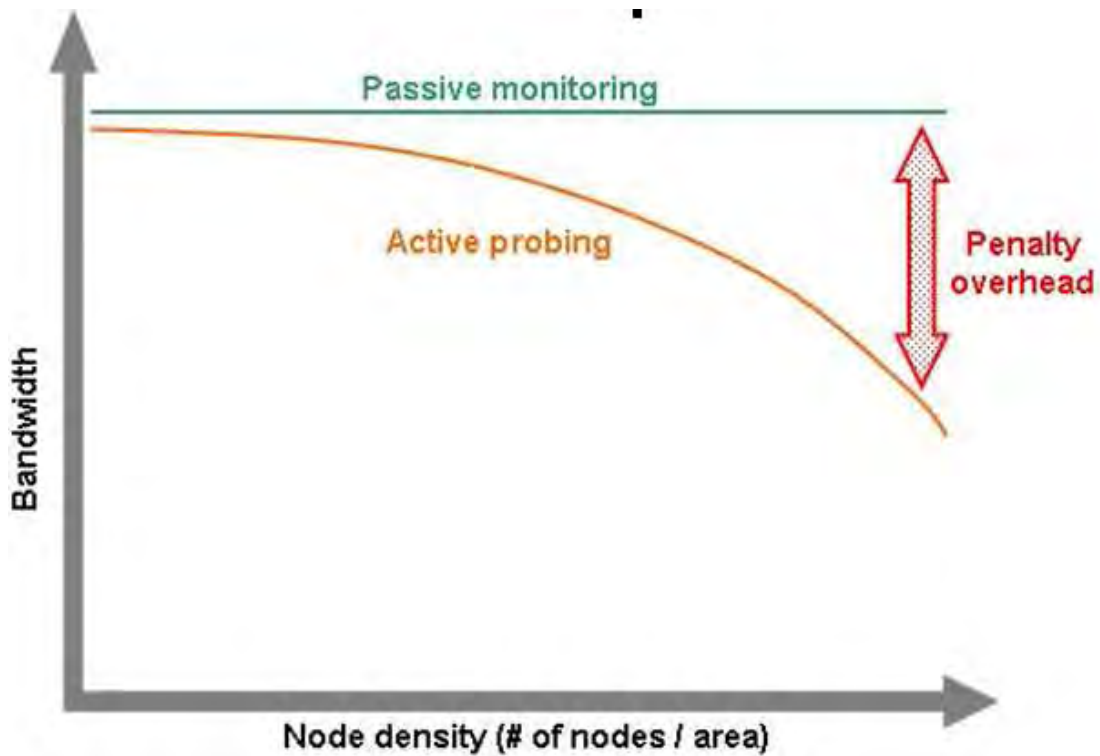

Figure 2.2: Comparison of passive monitoring and active probing techniques.

Recently the passive monitoring technique has gained much popularity and the reason being that when considering wireless network measurements, the passive monitoring technique serves to characterize the traffic at any particular point of the network with zero overhead [9]. All of this makes the passive technique a popular choice.

Traditionally, wireless network measurements taken on the wireless side of a network have relied on single-radio nodes. As was shown in previous studies (e.g. [10] or [11]), the quality of the network measurements depends on issues such as the wireless channel characteristics or the accuracy of the measurement tool that is being used. As a result, careful calibration of the measurement tools is usually necessary and often becomes a critical aspect of the single-radio wireless network measurements.

Regarding the impact of the wireless channel on the measurements, earlier studies of IEEE 802.11 links [12], [13], and [14] have found that packet losses are not easily predicted and depend on the traffic. This is caused by movements in the environment, either of the receiver or obstacles which induce slow changes in the channel due to Rayleigh fading. In the case of static outdoor IEEE 802.11 measurements [14], the highly directional antennas are susceptible to motion caused by wind which is a possible explanation for their random packet losses.

The study presented by Henty in [10] describes a relationship between active measurements and the propagation characteristics of the wireless channel. Specifically, the study comes up with an empirical model where two software tools were created to conduct an extensive measurement campaign to evaluate the performance of two IEEE 802.11b access points (APs) under ideal, multi-user, and interference scenarios. The data from this measurement campaign was then used to create empirically-based throughput prediction models. The resulting models were first developed using RSSI measurements and then confirmed using predicted signal strength parameters. Also the model relates the received SNR and the maximum wireless traffic throughput that can be injected in the network. This model was extended in [15] by Na et al.

In a previous companion study [16] to this paper, it was shown that when using different combinations of WLAN hardware devices to establish a wireless communication, the observed performance varies significantly. As a result, the maximum number of packets that can be injected in a wireless network is limited not only by the application but also by the hardware tools being used. In the same study,

the authors provided some experimental performance bounds for commonly used hardware devices.

Regarding the performance of passive measurement techniques, Yeo et al. (see [17], [18], [19]) showed that care should be taken when analyzing traces obtained using off-the-shelf wireless sniffers, e.g. Wireshark, as they are prone to lose part of the observed traffic. They observed that both the wireless channel behavior and the performance of the wireless devices cause information loss in sniffer traces. They also devised a method to enhance the view of a network obtained with a sniffer by merging (and synchronizing) traces coming from various independent sniffers that are monitoring the same communication. The results in [16] also provided bounds on the maximum performance that can be expected from an off-the-shelf wireless sniffer tool.

2.2.3 Why accurate link quality measurements?

Wireless link quality varies with environmental factors, such as interference, multipath effects, and even weather conditions [20], [21], [22]. Due to their typical deployment in large and heterogeneous areas, the wireless link quality of multi-hop WMNs can fluctuate significantly. Moreover, the various network routing protocols, such as the shortest-path and geographic routing protocols, are designed under the strong link-quality assumption and often suffer performance degradation or weak connectivity as a result [20], [23], [19].

Accurate link-quality measurement is essential to solve the following problems associated with varying link-quality in WMNs, as one can see from the following user cases:

- *Selection of the best relay node*: Accurate link-quality information can reduce the recovery cost of lost frames caused by link-quality fluctuations. For example, ExOR [24], [25] and MASA [26] attempt to reduce the number of transmissions with the help of intermediate relay nodes in retransmitting lost frames. Both solutions are based on capturing effects that allow in-range nodes to cooperatively relay “overheard” frames, but a key question is how to select the relay node that has the best link quality. This thesis elaborates on this topic in Chapter 3.

- *Supporting Quality-of-Service (QoS)*: Wireless link quality information enables applications and network protocols to effectively address users’ QoS requirements. For example, applications such as VoIP and IPTV can dynamically adjust the service level that can be sustained by varying link quality in the network. On the other hand, link-quality-aware routing protocols [27], [28] can accurately locate a path that satisfies the QoS requirements (e.g. in terms of throughput and delay) based on the link-quality information.

- *Network failure diagnosis*: Link-quality statistics can be used to diagnose and isolate faulty nodes/links in WMNs and to facilitate network management [29], [30]. WMNs covering shopping malls, a campus, or a city usually consist of a large number of nodes where each node must deal with site-specific link conditions. Thus, WMNs require accurate information on link conditions for troubleshooting.

Motivated by these and other user cases, this thesis will address how to measure link-quality and how beneficial accurate link quality measurements can be in efficiently utilizing network capacity.

2.2.4 Problems with performance measurements and existing techniques

The increasing deployment of WMN technologies and infrastructure is leading to an increased use of applications such as IP telephony, video streaming, public surveillance etc., and in turn these applications often demand a good link performance from the network. However, due to their deployment in large and heterogeneous areas, wireless links often experience significant quality fluctuations, performance degradation, and weak connectivity [20], [23].

To deal with such wireless link characteristics, significant efforts have been made to improve the network performance by mitigating the impact of unexpected link-quality changes. For example, ExOR [24], [25] is a routing protocol that tries to reduce the number of retransmissions via cooperative diversity among neighbouring nodes. MASA [25] is a MAC-layer approach that tries to minimize the overhead in recovering lost frames via nearby “salvaging” nodes. Finally, NADV [31] is a link metric that assists a geographic routing protocol to choose the relay node by optimizing the tradeoffs between proximity and link quality.

In addition to the above efforts, accurate measurement of wireless link quality is essential to dealing with link-quality fluctuations for the following reasons. Firstly,

the three solutions mentioned above rely heavily on the availability of accurate link-quality information to select the best relay nodes. Secondly, applications such as video streaming and VoIP also need the link-quality information to support QoS guarantees over WMNs. Thirdly, diagnosing a network, especially a large-scale WMN, requires accurate long-term statistics of link-quality information to pinpoint the source of network failures and reduce the management overhead [29]. Finally, WMNs commonly use multiple channels [27], [32], [33] and determining the best-quality channel among multiple available channels requires the information on the quality of each channel. Unfortunately, there are several limitations in using existing techniques to measure the quality of links in WMNs. Broadcast-based active probing (BAP) has been widely used for link-quality-aware routing [24], [27], [28]. Even though it incurs a small overhead (e.g. 1 probe packet per second), broadcasting does not always generate the same quality measurements as actual data transmissions due to different PHY settings (e.g. different modulation schemes). Thus, BAP can often provide inaccurate link-quality measurements. Finally passive monitoring has been suggested as an efficient and accurate method [31]. It makes use of network traffic, as it selects neighbours with the optimal trade-off between proximity and link cost. This is realised by self and neighbouring passive frame monitoring. But the method proposed in the work also incurs an overhead arising from the probing of idle links.

2.2.5 Limitations of existing techniques

There has been a significant volume of work on performing link-quality measurements. Here we discuss the advantages and disadvantages of using these techniques for WMNs.

1) Accuracy and Efficiency: A measurement technique must yield accurate results at as low a cost as possible. BAP has been widely used for adopting link-quality-aware routing metrics such as expected transmission count (ETX) [28] and expected transmission time (ETT) [28]. BAP uses simple broadcasting of identical probe packets from each node and derives link-quality information by multiplying the percentage of successful transmissions in each direction. Even though it is inexpensive, broadcasting uses a fixed and low data rate (e.g. 2 Mbps) which is more tolerant of bit errors than other rates and may differ from the actual data transmission rates (e.g. 11 Mbps) used. Thus, BAP yields less accurate link-quality information than a unicast-based approach. Note that, although recent device drivers (e.g., MadWiFi [34]) allow for using multiple data rates in broadcasting data, such multi-rate BAP will increase the probing overhead.

A unicast-based approach to measuring link bandwidth [28], [35], [36] can yield accurate results as it uses the same data rate for probing a link as that for actual data transmissions over the link. However, frequent probing of link to each neighbouring node incurs a higher overhead than BAP. As the number of neighbour nodes increases, probe packets may consume a significant portion of the channel capacity.

Passive monitoring (which avoids the transmission of probe packets) yields accurate link-quality measurements without incurring any overhead. Signal-to-noise ratio (SNR) monitoring may be the easiest to implement, but it is shown to be not the only factor to determine the actual link quality [20]. Self-monitoring [31] can be attractive

due to its use of actual data-frame transmission results. However, it also incurs an overhead in probing links when there are no data packets sent over them.

2) *Flexibility and Feasibility*: Measurement techniques must be flexible enough to cope with time-varying link quality. First, a periodic measurement which captures link quality only for a certain period as in [37] and [38] might be the simplest way to monitor link conditions. However, it yields poor measurement accuracy in wireless environments due to frequent link-quality fluctuations or requires significant efforts to determine the optimal measurement period.

On the other hand, the simple on-demand link-quality measurement used in MANETs [39], [40] might be cost-effective. However, it mainly focuses on link connectivity (i.e. a binary value indicating connectivity or not) instead of the actual wireless link quality. Even though several approaches (e.g. [41]) have been proposed to elaborately measure link quality using SNR, their main purpose is to maintain stable connectivity rather than adapting to the link dynamics in real time.

Finally, the measurement techniques have to be easily implementable and deployable in existing WMNs. BAP and unicast-based approaches can be implemented at any protocol layer without requiring any significant system changes. Passive monitoring can be developed in the network and MAC layers. However, it needs to exploit the information from the MAC layer which might not be available to the user [42].

Having studied the advantages and disadvantages of the existing techniques to minimize the overhead associated with performance measurement, it is proposed to explore the feasibility of using a passive monitoring technique to predict the *PER*.

2.2.6 The study of multi-radio Mesh

As this thesis is set in a multi-radio context, it is worth considering other research studies in the area of multi-radio mesh networks.

The current state-of-the-art mesh networks which use off-the-shelf 802.11-based network cards are typically configured to operate on a single channel using a single radio. This configuration adversely affects the capacity of the WMNs due to many factors as identified in [43]. In order to reduce the channel contention and increase the capacity of mesh network it may be beneficial to employ WMN nodes with multi-radio devices. Therefore the shift from single radio to multi-radio WMNs is an inevitable trend. From the wireless network experiments conducted in [44] or [45], one can find many advantages of using such architecture to take measurements in a wireless network. For instance, multi-radio nodes can take advantage of issues such as spatial diversity to overcome limitations posed by high wireless channel variability.

Equipping each mesh node with multiple radios is emerging as a promising approach to improving the capacity of WMNs. First, the IEEE 802.11b/g and IEEE 802.11a standards provide 3 and 12 non-overlapping (frequency) channels, respectively which can be used simultaneously within a neighborhood (by assigning non-overlapping channels to radios). This then leads to efficient spectrum utilization and increases the actual bandwidth available to the network. Second, the availability of cheap off-the-shelf commodity hardware also makes multi-radio solutions economically attractive. Finally, the spatial-temporal diversity of radios operating on different frequencies

with different sensing-to-hearing ranges, bandwidth, and fading characteristics can be leveraged to improve the capacity of the network.

Although multi-radio mesh nodes have the potential to significantly improve the performance of mesh networks, they are more complex than single-radio WMNs as they face many constraints and challenges related to channel selection and degradation of overall throughput when using multiple Network Interface Cards (NICs) in a node, etc. The ideal multi-fold performance improvement is simply not possible to achieve in a real network. Extensive research has been done in the area regarding the performance degradation and the evaluation has typically been addressed through simulations. However, the research community recently started experimentally evaluating mesh routers [7], [20], [28]. We should note at this point that the impact of multiple WLAN cards has been briefly described in [28] where it was reported that no two IEEE 802.11a and IEEE 802.11g cards could coexist in the same box without significant performance impact. In addition, in [45] the authors suggest that Netgear WAB501 cards require a separation of 15 cm, while Cisco Aironet 340 cards appeared to generate interference in the vertical plane and a vertical separation of 7.5 cm was necessary to eliminate interference. Furthermore, in [44] the authors suggested that simultaneous activation of multiple radios inside the same node leads to degradation in performance due to: i) board crosstalk, ii) radiation leakage, and iii) inadequate separation between the several antennas.

2.2.7 The study of multi-hop wireless mesh

Though the multi-hop configuration is not within the scope of this thesis as only the single hop scenario is considered, it is still worth discussing as a preparation for further studies.

The shift from single-hop wireless networks to multi-hop wireless networks leads to many possible design choices for the architecture of an AP. Each AP can simply feature one radio and forward traffic not destined to it (as in [28]). Alternatively, it can feature several radios to form wireless point-to-point links with neighboring nodes. When these radios are operated on non-interfering frequencies the capacity of the network increases as a function of the number of radios [6], [7]. Nonetheless, given the several degrees of freedom in the design of mesh routers (e.g. number of radios, technologies of radios, etc.) a meaningful comparison among these efforts is not possible. For instance, in [20] an outdoors multi-hop wireless network is described. Each node operates a single radio and the results refer to the performance of the network when packets are broadcast (no multi-hopping is actually tested). In [28] a testbed of 23 nodes is described. The testbed features 2 radios per node, one operating at 5GHz using IEEE 802.11a and the other at 2.4GHz using IEEE 802.11g. The authors considered alternative ways to route traffic across such a network. Lastly, in [7] the authors simulate a 2-radio wireless router using two laptops connected through an Ethernet cable, each one featuring an IEEE 802.11b wireless card. They then studied the performance improvement achieved when using 2 radios and algorithms for setting up and tearing down paths through the multi-hop network. Lundgren et al. [46], Yarvis et al. [47], and De Couto et al. [48] report much lower performance on deployments of multi-hop routing systems than that predicted in simulation and all

have observed in one way or another that the problem is a predominance of intermediate-quality links. They propose solutions that involve measuring link quality and carefully routing through the best links.

2.3 Summary

WMNs are gaining in popularity due to their low cost, ease of configuration and self healing abilities. However, their large scale implementation gives rise to degradation of performance, weak connectivity etc due to the increasing complexity of path selection for the support of routing.

In general there are two techniques that can be employed to obtain these performance metrics: active probing and passive monitoring. Active probing involves accessing the wireless network through broadcasting probe packets. It has the disadvantage that it generates a transmission overhead. On the other hand, passive monitoring is a technique whereby all network transmissions are passively intercepted and subsequent processing produces the performance metrics. It has the advantage that it does not generate an overhead.

From the peer studies presented earlier, there has been much research effort conducted into reducing the overhead of performance measurement and all of the reported studies suggest that passive monitoring techniques can produce accurate results with the least overhead.

Traditionally, the majority of the WMN research efforts to date have been concerned with a study the performance of the two techniques used separately or in some combined technique [8]. However, to date little attention has been paid to the correlation between passive monitoring and active probing techniques and the possibility of using these techniques interchangeably in a multi-radio environment. Also, much of the research has been conducted using computer simulations which offer an efficient and flexible means to evaluate a network. However, in these simulations, background traffic and random noise are normally not taken into account and often unrealistic traffic traces are employed. Consequently, performance evaluations obtained through computer simulations may not reflect the actual performance obtained in real networks [50].

Thus, this thesis experimentally studies the correlation between the active probing and the passive monitoring techniques in order to study the possibility of applying such passive monitoring techniques in a single radio network. It then examines the characteristics of the multi-radio WMNs in order to prepare for the application of passive technique in a multi-radio network. Lastly it explores the feasibility of using a passive technique to replace the active performance techniques. In summary, this thesis proposes a novel approach to passive performance measurement on WMNS that produces an accurate estimate of the *PER* without incurring an overhead.

3 Technical Details

In this chapter, a detailed description is given of the test bed, all the relevant software tools and the experimental approach for a better understanding of the experiments and results presented in the next chapter.

As discussed in the introduction chapter, the experimental study consists of 3 major sections: The first section compares the effectiveness of the passive monitoring and active probing techniques in a single radio test bed, the second section investigates the problem of system performance degradation associated with multi-radio networks, and the last section adopts a similar approach as the first section by examining the feasibility of using passive monitoring techniques in multi-radio networks. The accuracy of the passive technique is then compared with active probing. Different test beds are used to carry out the investigations and these are described as follows:

3.1 Introduction to CSMA/CA and passive metrics

3.1.1 CSMA/CA

The Media Access Control (MAC) layer is a sub layer of the Data Link Layer specified in the seven-layer OSI model [59]. It provides addressing and a channel access control mechanism that makes it possible for several terminals or network nodes to communicate within a multi-point network.

The most important difference in terms of the MAC mechanism between wireless LANs and wired LANs is the impossibility to detect collisions. With the transmitting and receiving antennas immediately next to each other, a wireless node is unable to see any other signal but its own. As a result, the complete packet will have been sent before the incorrect checksum reveals that a collision has occurred between simultaneously transmitted packets. The successful operation of the network requires that the number of collisions is kept to a minimum

The channel access control mechanism provided by the MAC layer is essentially a multiple access protocol. This makes it possible for several stations that are connected to the same physical medium to share it. The multiple access protocol may detect or avoid data packet collisions. The MAC defined for IEEE 802.11 WLANs is based upon collision avoidance and is known as carrier sense multiple access with collision avoidance or CSMA/CA for short.

The collision avoidance mechanism in CSMA/CA requires wireless nodes or stations to delay their transmission for an additional random Backoff Interval after the medium becomes idle. The Backoff Interval is used to initialize the Backoff Timer. The Backoff Timer is decreased as long as the medium remains idle, stopped when the medium is sensed busy, and reactivated when the medium is sensed idle again. A station may transmit its frame when its Backoff Timer reaches zero. The backoff time is slotted (in IEEE 802.11b the duration of a time slot $Slot_Time = 20 \mu s$) and a station is only allowed to transmit at the beginning of a time slot. The Backoff Interval is randomly generated using a $Backoff\ Interval = BC \times Slot_Time$ where BC is a pseudorandom integer drawn from a uniform distribution over the interval $[0, CW]$ and

where CW is known as the Contention Window. The effect of this procedure is that when multiple stations are deferring and go into random backoff, the station selecting the smallest Backoff Interval will be the first to have its Backoff Timer reach zero and transmit its packet. Fairness is promoted as each station must re-contend for access after every transmission. Occasionally, two or more stations may choose the same BC value leading to a collision as the stations involved will transmit their frames at the same time. To resolve collisions, an exponential backoff scheme is used whereby the size of the CW is doubled after each unsuccessful transmission [61] and a retransmission of the packet is attempted.

3.1.2 *Passive metrics*

Contention

In packet mode communication networks, contention is a consequence of the MAC mechanism in a shared broadcast medium [60]. All connected stations compete against each other for transmission opportunities as described under the CSMA/CA scheme where occasionally collisions will occur. A collision is a condition that occurs when two or more data stations attempt to transmit at the same time over a shared channel. The *contention* represents the average number of stations competing for each access opportunity to the medium. The greater the contention the greater the competition for access and the higher the probability of a collision occurring. Collisions reduce the throughput of a station and lead to an overall reduction in the capacity of the network. The *contention* parameter used in this thesis is obtained passively by the WRM as introduced in Section 3.2.1.

MAC Bandwidth Components - BW_{idle} and BW_{busy}

Here BW_{busy} represents the portion of the time on the medium used in the transport of the total traffic load. Similarly, BW_{idle} represents the portion of the time on the medium that is complementary to BW_{busy} and may be used by any station to win access opportunities for its load. Associating the transmission of a packet with a particular station k leads to the concept of the load bandwidth $BW_{load}(k)$ which corresponds to that portion of time on the medium used in transporting its load and is directly related to the throughput of the station.

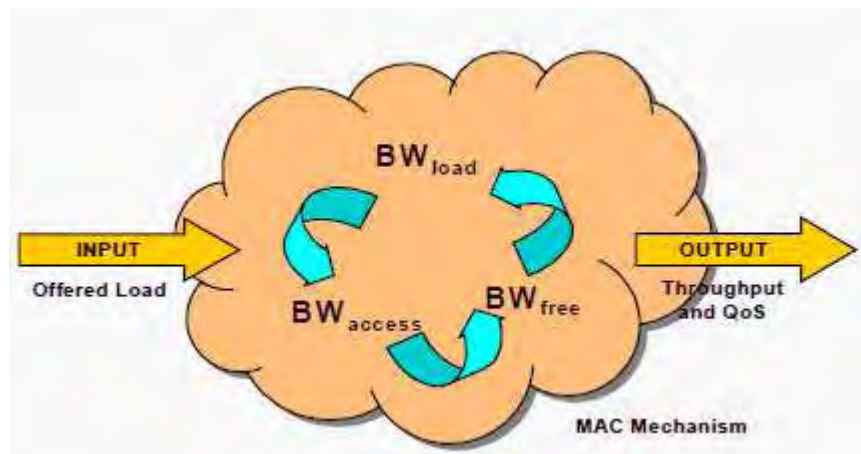

Figure 3.1: MAC layer bandwidth components concept

Inevitably some bandwidth will be lost due to collisions between multiple stations attempting to transmit at the same time. It is worth noting here that, apart from collisions, stations do not share their load bandwidths during their transmissions. In other words, once a station has won access to the medium, it has exclusive use of the medium for the duration of the transmission of its frame. This is in contrast to the idle bandwidth which is shared by all stations in the sense that any station can make use of the idle time intervals on the medium to allow periods $Slot_Time$ to elapse thereby allowing the Backoff Timer to count down to zero.

Received Signal Strength RSSI

RSSI is the relative received signal strength in a wireless environment, in arbitrary units. The *RSSI* value is derived from the Clear Channel Assessment (CCA) function that is used to determine whether the medium is deemed to be busy or idle. Once the card is clear to send, a packet of information can be sent. The end-user will likely observe an *RSSI* value when measuring the signal strength of a wireless network through the use of a wireless network monitoring tool like Wireshark, [Wildpackets Omnipcap] [62].

RSSI measurements are unitless and are usually highly vendor dependent. For example, Cisco Systems WLAN cards have a *RSSI* value between 0 and 100. Another popular Wi-Fi chipset is manufactured by Atheros. An Atheros based WLAN card will return an *RSSI* value of between 0 and 127 (0x7f) with 128 (0x80) indicating an invalid value. The *RSSI* readings in this thesis are all direct readings from Atheros based WLAN cards obtained by using the *ifconfig* command in Linux.

3.2 Single Radio Test bed

The single radio test bed was set up to conduct a comparison between the active and passive monitoring techniques. The results obtained from this experimental set up will be used as a stepping stone in progressing to the multi-radio investigation. The details of the test bed and the experimental approach are described next.

3.2.1 System description

All experiments have been carried out using the CNRI wireless mesh test bed [58]. This is a multi-purpose networking experimental platform which consists of 17 IEEE 802.11b/g based mesh routers, located around the DIT Focas building. Various usage statistics about the CNRI mesh test bed can be obtained from <http://mesh.cnri.dit.ie>. Each wireless node in the mesh test bed comprises a Soekris net4521 board [57] running the Pebble Linux distribution.

To facilitate repeatable experiments and accurate data analysis, we have utilized several different tools for network monitoring and diagnosis. These tools are now described:

WLAN Resource Monitor (WRM): The WRM is a tool developed by the CNRI that is capable of measuring both the availability and utilization of network bandwidth in real time and on a per node basis [56]. It operates non-intrusively by passively monitoring the wireless transmissions on the medium and therefore does not in any way interfere with the normal flow of traffic on the network. Moreover, it does not require WEP/WPA security keys to operate and therefore does not pose any security risks when deployed on encrypted networks. The WRM differs from other WLAN Analyzer tools in that it specifically addresses operation at the L2/MAC layer which is where the network bandwidth is shared out between the competing nodes. Consequently, this application can provide the type of critical network bandwidth measurements required for effective radio resource management. During the experiments, this application was utilized to measure the passive performance metrics

such as *rssi*, *contention*, *available bandwidth* etc. A number of these metrics were subsequently chosen to establish the *PER* estimator.

Packet error rate (*PER*) calculation tool: *PER* is an important method of actively measuring the network performance. In our performance analysis we have developed a *PER* calculation tool based on the Pcap Library Engine [55]. It works by applying protocol type filters (e.g. ICMP, SIP etc) to the packets sent from one node to another and recording the number of packets transmitted and received over a given time interval. This allows the *PER* to be calculated. This tool was installed on both the transmitting and receiving stations. It was operated in parallel with the WRM application to allow for a comparison between the active probing and passive monitoring techniques.

3.2.2 Network setup and configuration

See Figure 3.1 below for the test bed used in the single radio experiments.

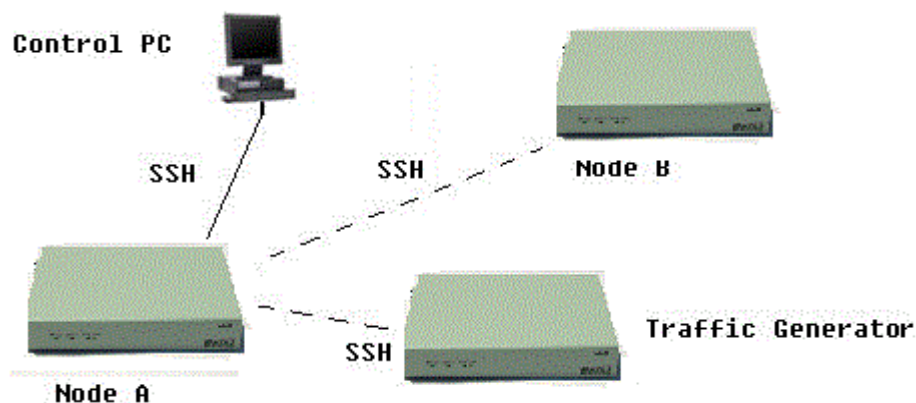

Figure 3.2: Single radio experimental test bed.

The experimental test bed consists of 3 Soekris net 4521 boards (equipped with a single radio) as shown in Figure 3.2. Two of the net 4521 boards were configured to operate in the Ad-Hoc mode, while the third node was used to generate different types of background traffic on the network in various patterns such as Poisson, Uniform or Exponential etc. Finally, a control PC is used to control the operations of all 3 nodes using the SSH protocol.

3.2.3 Experimental approach and evaluation metrics

The experimental approach involves first gathering the performance metrics using both active and passive probing techniques, and then calculating and plotting the correlation between the measurements.

Initially, experiments were carried out to study the correlation between the individual *RSSI* and the idle bandwidth (BW_{idle}) measurements (passive), and the *PER* measurements (active). Next, the correlation between the combined metric involving the *RSSI* and BW_{idle} measurements and the *PER* was studied. A total of 70 experiments were conducted. Each experiment that was carried out had a typical duration of between 17 and 24 hours.

During the experiment, the *PER* was obtained by using active probing. This was done by sending ICMP broadcast packets from Node A to Node B, and with the *PER* calculation tool the *PER* was calculated on the receiving node based on the successfully received ICMP packets sequence number. The passive monitoring used the CNRI's WRM tool where the BW_{idle} and *RSSI* values were obtained.

To calculate the correlation between the two data sets, the Pearson correlation coefficient is used which is a dimensionless index between -1.0 and 1.0 that reflects the extent of the degree of correlation between the two data sets. The closer the coefficient is to -1.0 or 1.0, the higher the correlation is between the two data sets [54]. Mathematically, the Pearson correlation coefficient is given by:

$$r = \frac{\sum (x - \bar{x})(y - \bar{y})}{\sqrt{\sum (x - \bar{x})^2 \sum (y - \bar{y})^2}} \quad \text{Pearson correlation coefficient} \quad (3.1)$$

In the above equation, r denotes the correlation coefficient between two data sets (in our case these two data sets are *PER* and combined passive function value). With all the r values calculated for each of the test cases, one was able to plot all of these values against the number of the test cases. In this way one can determine if the passive and active monitoring techniques yield a reasonably high and stable correlation amongst these test cases.

3.3 Wireless Multi Radio Test bed

Following on from the previous single-radio test cases, the wireless multi-radio test bed was setup. The goal here is to study the impact of using multiple radios in a WLAN node. One of the biggest issues addressed in this work is the throughput performance degradation associated with multi-radio networks as reported in [44]. This section of experiments aims to conduct a detailed investigation of a multi-radio network's performance, and again to examine if passive monitoring techniques can be applied to such networks.

3.3.1 System Description

All experiments have been carried out using off the shelf equipment such as Dell PCs, external Wi-Fi cards (NICs). As a base platform we have used two PCs running the Fedora Linux distribution with a total of eight 3Com IEEE 802.11a/b/g NICs (up to four in each PC).

To facilitate repeatable experiments and accurate data analysis, we have utilized several different tools for network monitoring and diagnosis, as follows:

- Madwifi driver: An open source wireless driver for Linux.
- IPerf: A traffic generator used to measure the throughput performance.
- D-ITG toolsets: A traffic generator used to saturate the network.

3.3.2 Network setup and configurations

See Figure 3.3 below for the test bed used in the wireless multi-radio experiments.

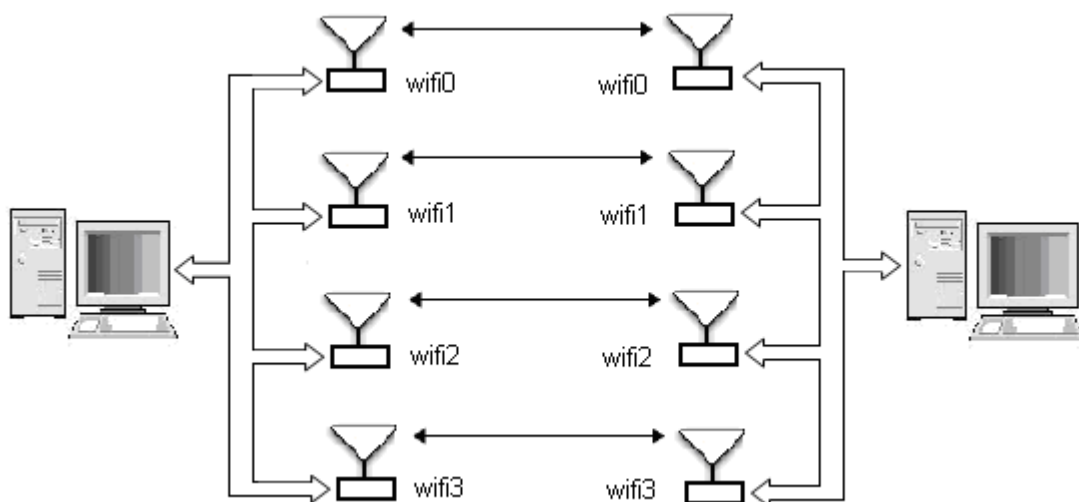

Figure 3.3: Wireless multi-radio experimental test bed.

The experimental test bed comprises 2 PCs that are positioned eight meters apart from each other in a dedicated area of the laboratory where the movement of people and the access to the experiment can be kept to a minimum. Each PC can host up to 4 WLAN NICs. These 8 NICs have been configured to operate in the Adhoc (i.e. infrastructureless) mode to form 4 transmitter/receiver (Tx/Rx) pairs operating on orthogonal (i.e. non-overlapping) channels.

All WLAN NICs operate in the IEEE 802.11a mode with the antenna diversity feature disabled. This is because when this feature is enabled a second antenna on the NIC is used which leads to higher CPU usage. During these experiments, a fixed transmission rate of 54Mbps was used on each interface, i.e. automatic rate adaptation was disabled. As the channel medium was stable and the distance between the stations is short, the use of a fixed maximum rate would allow the maximum achievable throughput for the system to be achieved.

3.3.3 Experimental approach and evaluation metrics

3.3.3.1 Experiments at the Tx node

1. Initially, a baseline performance for the throughput was established by measuring the maximum achievable throughput between a single Tx/Rx pair (i.e. involving just two NICs). The other six NICs are disabled. Measurements are performed with the Iperf toolsets.

2. Having established a stable and reproducible baseline throughput, the impact of multiple wireless interfaces within a node was studied. The objective was to determine if there is any negative impact on the throughput performance as a result of cross-talk between the wireless interfaces. During this study, a single receiving node with a single interface was used and the number of transmitting interfaces in the transmitting node was increased until all four PCI slots were occupied. Each time an additional wireless interface card is inserted into the PCI slot, the card is set to the monitor (passive) mode and tuned to an orthogonal channel. The maximum achievable throughput is measured as described in step 1 above. The CPU usage is obtained by using the Linux *top* command. It provides an ongoing measure of processor activity in real time. It displays a listing of the most CPU-intensive tasks on the system, and can provide an interactive interface for manipulating processes. It can sort the tasks by CPU usage, memory usage and runtime.

3. Steps 1 and 2 are then repeated with a different tool (i.e. D-ITG as this tool has the capability to both generate and measure traffic throughput) to generate a maximum throughput or saturation network condition, so the impact of an additional NIC on the computational overhead can be measured. The additional cards are set to the AP mode. The throughput results for the saturated network were then recorded.

3.3.3.2 Experiments at the Rx node

Similar procedures are applied at the Rx node, but here different operation modes (i.e. station mode, AP mode, monitor mode etc.) of the NICs are used while the saturated throughput is recorded. Under the saturation condition, one of the causes of the changes in the throughput value would be the result of using various operation modes such as monitor mode, AP mode etc. Also the Tx transmission power is varied to study its impact on the throughput. During each test, the link quality metric which is a measurement indicator of the channel link quality provided by Madwifi driver were recorded with the Linux *Ifconfig* command. The D-ITG tool sets are used to generate a saturated network condition and to estimate the throughput for each scenario.

In both sections 3.2.3.1 and 3.2.3.2, the experimental tests were carried out for a duration of 300 seconds each and were repeated 5 times and an average value calculated.

3.4 Cabled Multi Radio Test bed

During the previous two test phases, the effectiveness of using the passive monitoring technique in a single-radio network was examined and the performance of using multiple NICs in a network was studied. Next, the intention is to examine the feasibility of using the passive monitoring technique in a multi-radio network. The ultimate goal of this section is to replicate the active performance metric (i.e. the *PER*) with our proposed passive combined model. The details of the experiments are given below.

3.4.1 System Description

All experiments in this section have been carried out on a cabled platform as shown in Figure 3.3 below. It was developed by utilizing attenuators, cables and signal splitters etc. The reason for doing this is to establish a stable network environment by eliminating all possible external influences. This approach enabled us to gain more reliable and reproducible results. The same set of tools as described in section 3.1.1 were also used here. In addition the D-ITG toolsets were also utilized to provide background traffic.

3.4.2 Network setup and configurations

See Figure 3.4 below for the test bed used in the cabled multi-radio experiments.

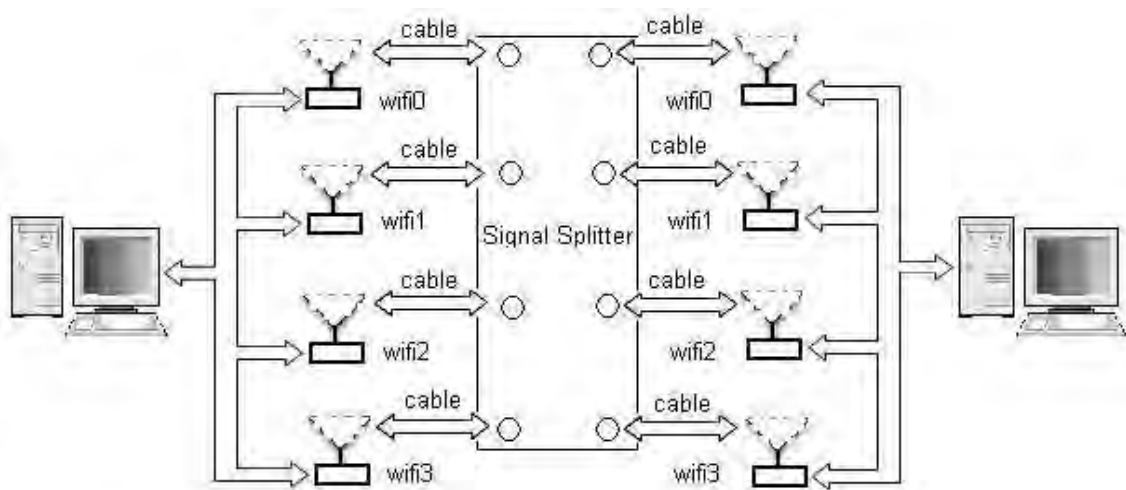

Figure 3.4: Cabled multi-radio experimental test bed.

The cabled multi-radio test bed used off-the-shelf equipment comprising eight 3Com wireless IEEE 802.11a/b/g NICs. All of the adapters were inserted into the parallel

PCI slots of the PCs where they share a common system bus. As mentioned earlier, these adapters were then connected together through microwave coaxial cables and couplers etc. Since this cabled network provides excellent channel condition, the *PER* should be low. Therefore several 30dB attenuators were added in series along with the cable to introduce signal attenuation – the *RSSI* at the Rx has been dramatically reduced and this subsequently produced higher *PER*.

These 8 NICs were configured to operate in the Ad hoc (i.e. infrastructureless) mode to form 4 pairs operating on orthogonal channels. All NICs operated in the IEEE 802.11a mode with the antenna diversity feature disabled and a fixed transmission rate of 54Mbps on each interface as discussed in section 3.2.2.

3.4.3 Experimental approach and evaluation metrics

The experimental approach involves gathering the performance metrics using both active and passive probing techniques, and then forming a combined function model which will yield a high correlation with the actively obtained parameter. This proposed combined function model is used to estimate the *PER*.

The *PER* is obtained by using active probing. This is done by sending ICMP packets between two WLAN stations where the *PER* is calculated at the receiving node based on the successfully received ICMP packets sequence number. The passive monitoring uses the CNRI's WRM tool where the *RSSI*, *Contention* and *LineRate* values were obtained. The reason why this particular choice of parameters has been selected is explained below.

Selection of performance metrics:

The goal here is to combine several passively obtained metrics together to realise an estimator for the *PER* and to compare this estimate with the actual *PER* obtained by measuring it directly.

There are many performance metrics that can be passively obtained by the WRM to indicate network performance, typical metrics are *LineRate*, *RSSI*, *Contention*, *BW_{idle}* and *BW_{busy}* etc. Since we wish to select the most representative ones to combine together to estimate the *PER*, the nature of these metrics and their inter-dependencies need to be studied carefully. The Table 3.1 below shows the dependencies between the various passively-obtained performance metrics.

	<i>LineRate</i>	<i>RSSI</i>	<i>Contention</i>	<i>BW_{idle}</i>	<i>BW_{busy}</i>
<i>LineRate</i>	-----	Y	Y	Y	Y
<i>RSSI</i>	N	-----	N	N	N
<i>Contention</i>	Y	N	-----	Y	Y
<i>BW_{idle}</i>	Y	N	Y	-----	Y
<i>BW_{busy}</i>	Y	N	Y	Y	-----

Table 3.1 Inter-dependencies of the passively gathered metrics.

All of the above inter-dependencies are illustrated in Figure 3.4 where they generally fall into four categories in relation to indicating network performance:

The first category is the channel bandwidth condition and the parameters that come under this category are the BW_{idle} and BW_{busy} bandwidths. Since they are complementary to each other in the WRM application, i.e. their relationship can be described as $BW_{idle} = 1 - BW_{busy}$, consequently only one of them is required to indicate the bandwidth condition of a given channel. It can be observed from Figure 3.4 that the bandwidth condition which is determined by network load gives rise to contention and subsequently to collisions in the channel. This will contribute to a higher PER . We have decided not to choose either BW_{idle} or BW_{busy} as a part of our combined metric in this experiment because these parameters have a direct correlation with *contention* as shown in the diagram below, not with the PER . Consequently, it is clear that using MAC layer bandwidth components to estimate PER is not a viable option.

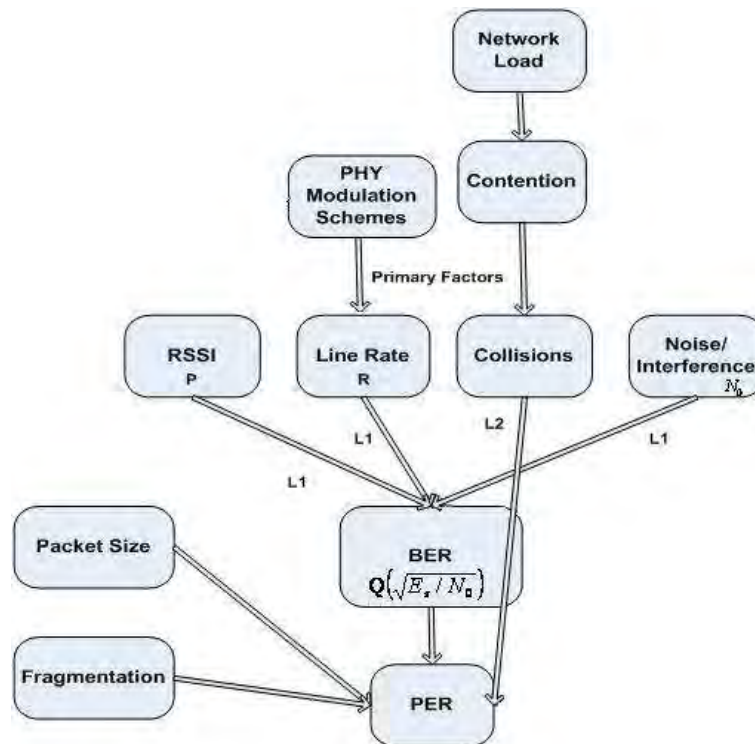

Figure 3.5: Factors that have impact on the PER .

The second category is the contention level in a given channel. The contention arises from the MAC method that is used to share access to the broadcast medium [51]. In an IEEE 802.11 WLAN network it arises from the fact that all stations have to compete against each other for a transmission opportunity. Most importantly, as shown in Figure 3.5, an increased contention level will result in a larger number of occurrences of packet collision and this directly leads to a higher *PER*. It is clear that the *Contention* parameter is a strong candidate for inclusion in this combined metric, so it becomes our first metric candidate in the combined function.

The third category is the transmission rate measurement in a given channel. This refers to the average channel transmission rate and this parameter is closely linked with the rate adaptation algorithm. The majority of rate adaptation algorithms take account of successive packet re-transmissions and the number of successive packet transmissions to adapt the transmission rate. When the number of packet re-transmission increases beyond a certain pre-set threshold, the rate adaptation algorithm will automatically lower the transmission rate to ensure more reliable communication and vice versa. Now let us consider the probability of the bit error rate in a channel. In the IEEE 802.11a mode, different modulation schemes such as BPSK, QPSK and 16QAM etc. are used for the different transmission rates, as shown in Table 3.2 below. However, they all follow a general mathematical formula in terms of the bit error rate P_b given by

$$P_b = Q\left(\sqrt{E_s / N_0}\right) = Q\left(\sqrt{ST / N_0}\right) = Q\left(\sqrt{S / RN_0}\right) \quad (\text{BER}) \quad (3.2)$$

where S denotes the received signal power, T denotes transmission time, R denotes transmission rate, $Q()$ is the complementary error function and N_0 denotes the noise power spectral density. As can be observed from this equation, when R increases the bit error rate will increase. There is a direct relationship between bit error rate and PER where

$$PER = 1 - (1 - BER)^n \quad (3.3)$$

where n denotes the length of the packet in bits and the assumption is that the BER is relatively low, it also assumes that the errors occur randomly and there are no burst errors. This expression is widely used in networking community, also known as the uniform hypothesis [52]. In short, the transmission rate has a direct correlation with PER , so the value of the average transmission rate or $LineRate$ becomes our second metric candidate for inclusion in our combined metric.

<i>LineRate</i>	Modulation schemes
6	BPSK
9	BPSK
12	QPSK
18	QPSK
24	16-QAM
36	16-QAM
48	64-QAM
54	64-QAM

Table 3.2 Modulation schemes used for different LineRates in IEEE 802.11a.

The last category is the $RSSI$ which is the received signal strength indicator. This is determined by the transmitter power. This parameter is widely used to measure link quality. For example, when two stations are being moved further away apart from

each other, the *RSSI* will reduce and the communications between the two stations will suffer from an increased *PER*. The mechanism behind this can be explained by the bit error rate equation (2) above. When the transmission rate R increases, the probability for a bit error increases which in turn leads to higher *PER*. Since *RSSI* is a primary factor represented by S in the BER equation, it is chosen to become our third metric to form the combined function.

Since we have chosen *contention*, *LineRate* and *RSSI* to form a combined function by using the multiple linear regression model. It is now necessary to examine the feasibility of using this proposed model. It is examined in the following two steps:

The first step is to calculate the correlation between the two data sets (i.e. combined function value and *PER* value) by the Pearson correlation coefficient. With an expected high and stable correlation with the active probing metric, it will demonstrate the effectiveness and feasibility of the proposed model.

The second step is to use this proposed passive model to estimate the *PER* which is obtained by using the active probing method and then this estimated *PER* will be compared with the recorded experimental value. The difference between the two *PER* values will reflect the accuracy of the proposed combined function model in a multi-radio network.

The accuracy of the passive estimator's estimation will serve to determine the feasibility of the proposed passive estimator.

The work presented in this thesis has investigated the feasibility of using passive performance metrics to predict the *PER* in a multi-radio wireless network, and the experimental results drawn from 1000+ hours of tests suggested that it is accurate, albeit under quite restricted and possibly ideal operating conditions. The obvious benefit of such method is that it has no bandwidth overhead associated with it. The percentage of overhead saving associated with the passive technique varies depending on packet sizes, probing frequency and routing protocols etc. In [53] it has been calculated that for an IEEE 802.11g probing scheme, there would be a 7.5% overhead saving for a packet size of 1470 bytes and 26% for a packet size of 60 bytes. And at the same time the associated computational effort (in terms of CPU load) has not significantly increased. Also, it results in a reduced interference which would be particularly attractive in high density WMNs.

4 Experimental Results

In this section the experimental results of this study are presented and analyzed. This chapter is divided into three sections corresponding to each of the experimental scenarios described in chapter 3. The first section shows that the passive monitoring technique yields a high correlation with the active probing technique (as discussed earlier in chapter 2). The second section demonstrates that the limited computing resources available at the wireless node are responsible for the throughput degradation associated with multi-radio networks. The third section discusses the feasibility of using the passive monitoring technique in multi-radio networks and its correlation with the active probing technique is investigated.

4.1 Single Radio Testbed

4.1.1 Correlation between the PER and the RSSI

Initially the correlation of the *RSSI* value of the nodes (i.e. obtained from the passive monitoring technique) and the *PER* (i.e. obtained from the active probing technique) was investigated for 20 test cases. Each test case has a typical duration of approximately 17 hours.

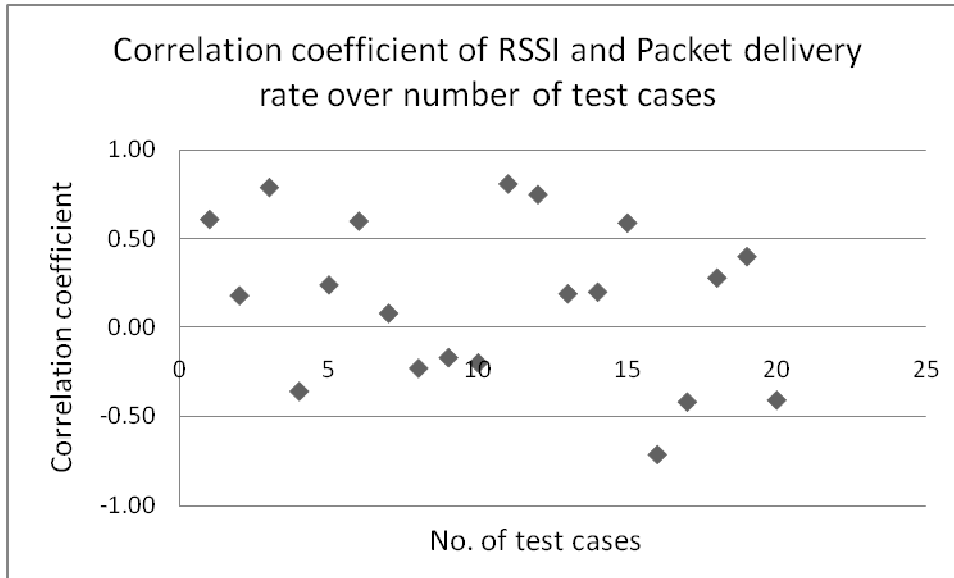

Figure 4.1: Correlation coefficient of *RSSI* and *PER* over all test cases.

From Figure 4.1 it can be observed that in the 20 test cases considered, there is no clear correlation between the *PER* and the *RSSI* value at the receiver nodes which would indicate that the use of a single performance metric (obtained using a passive monitoring technique) will not yield a high correlation with the active probing technique.

4.1.2 Correlation between the *PER* and the idle bandwidth (BW_{idle})

Next the correlation between the BW_{idle} value of the nodes (i.e. obtained from the passive monitoring technique) and the *PER* (i.e. obtained from active probing technique) was investigated through another study involving 20 test cases. These test cases were carried out in the same manner as the previous study where the typical duration of each test was approximately 20 hours.

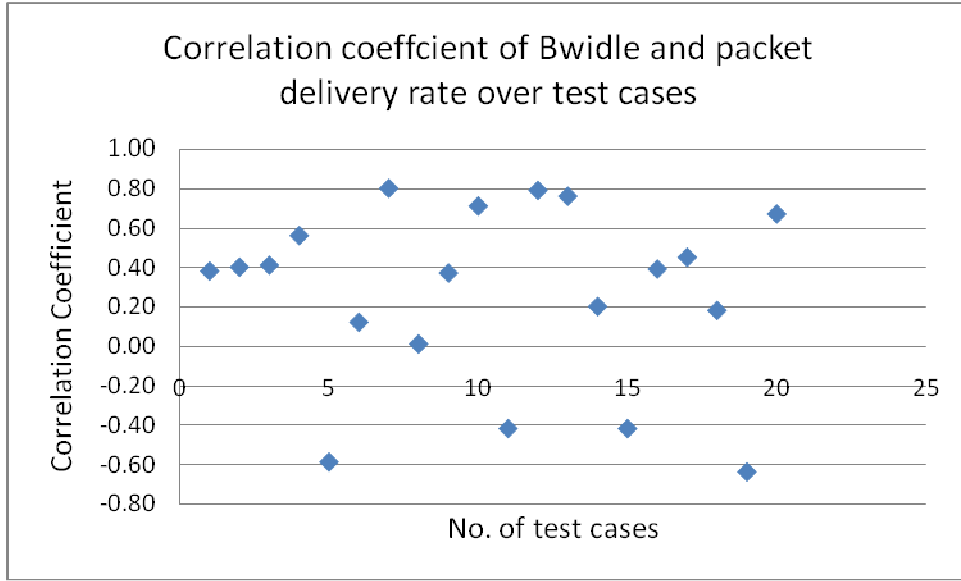

Figure 4.2: Correlation coefficient of BW_{idle} and PER over all test cases.

As can be seen in Figure 4.2, there is no discernible correlation between the PER and the idle bandwidth BW_{idle} for the 20 test cases considered. From these first two results, it is evident that a single performance metric obtained from passive monitoring is insufficient to establish a strong correlation with those from active probing.

4.1.3 Combining Passive Measurements

In order to more accurately reflect the link performance obtained from the passive monitoring technique, the $RSSI$ value and the BW_{idle} value are combined and normalised as follows:

$$F(RSSI, BW_{idle}) = \frac{RSSI * BW_{idle}}{30} \quad (4.1)$$

The reason that the factor 30 is used to normalize the function is that the *MadWifi* driver used in these experiments specifies that the $RSSI$ value of a strong signal will have a value of 30.

Figure 4.3 below shows the results obtained from calculating the correlation of the active probing technique and the passive combined function method. A total of 30 test cases were performed.

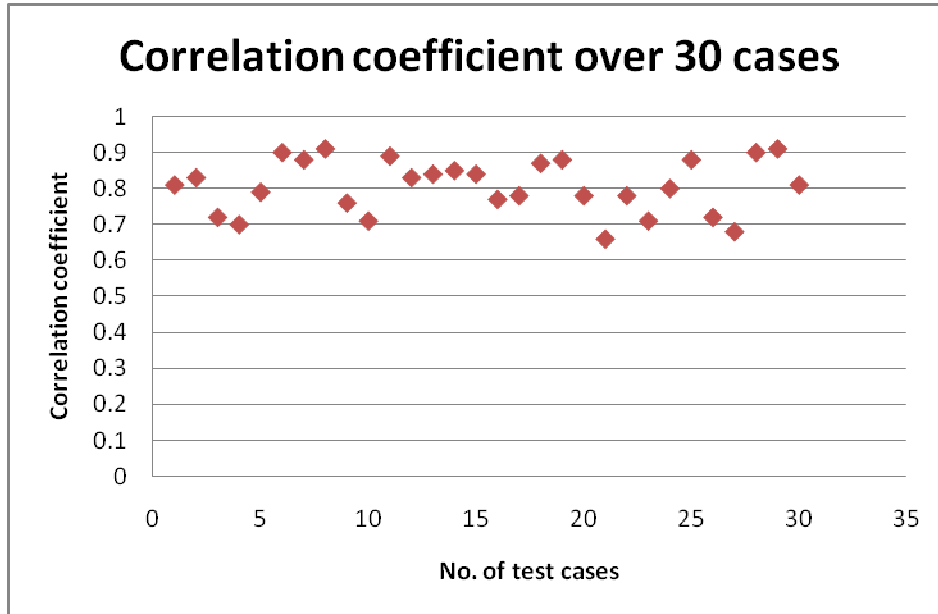

Figure 4.3: Correlation coefficient of the combined function and *PER* over all 30 test cases.

As shown in Figure 4.3, a high degree of correlation can be observed with a correlation coefficient between 0.7 and 0.9. This indicates that passive monitoring can have a good correlation with active probing if the combined function is used for the passive monitoring measurements.

In order to further verify the combined function in a network, background traffic was introduced. Figure 4.4 shows the correlation between the two techniques when they try to monitor the variation of the network traffic in terms of *PER*. The variation in the network load is produced by another *Soekris board* as explained in the previous chapter of this thesis.

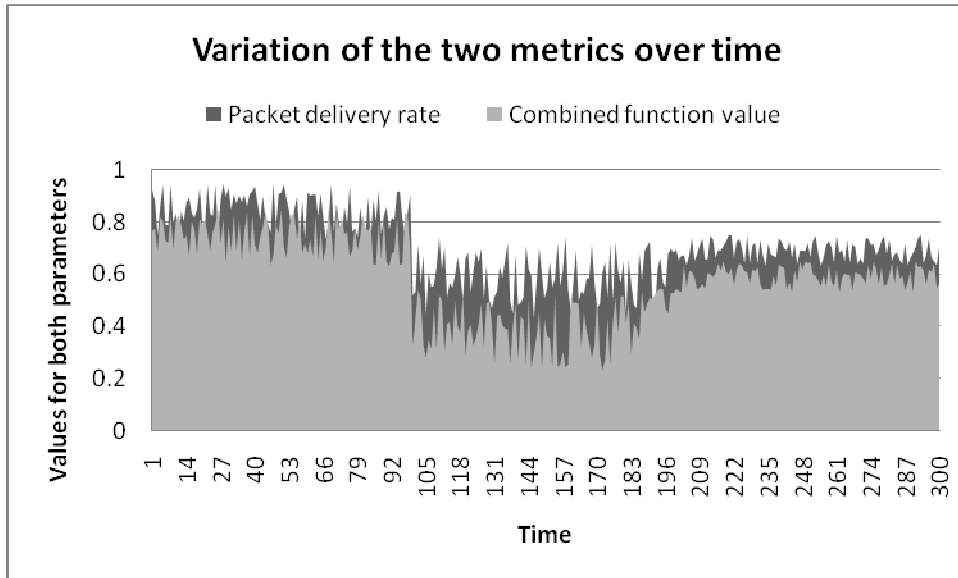

Figure 4.4: Variation in the combined function value and *PER* over time (Y-axis unit is percentage in true value).

Figure 4.4 shows how both the *PER* and the combined function values react to the variation in background traffic load. It can be observed that during the course of the experiments their reaction to this variation are quite similar, that is whenever the background load varies, the two performance metrics respond to it simultaneously. This indicates that both passive monitoring and active probing techniques can accurately reflect the network performance in terms of the *PER*.

4.2 Wireless Multi Radio Testbed

4.2.1 Throughput statistics under non-saturation condition at the Tx node

This section presents the results of the performance measurement under a non-saturation condition at the Tx node. Between the Tx and Rx nodes, data packets are transmitted by using traffic generation tools as explained in Chapter 3. Then the throughput between an active pair is firstly measured. This measurement will be re-

performed after an extra NIC is inserted into the Tx node. The CPU idle % is measured also.

Packet Size in bytes	Throughput (Mbps)			
	1	2	3	4
1470	34.8	33.9	31.9	30.3
1280	34.0	33.1	31.0	29.1
1024	31.7	30.7	29.0	26.4
756	28.8	27.3	25.1	22.1
512	25.3	22.9	20.2	18.2
256	15.6	15.2	13.3	12.8

Table 4.1 Throughput under non-saturation at the Tx node with different packet sizes and number of active interfaces.

Table 4.1 above contains the measured throughput measurements between the active pair of NICs and it shows the changes in throughput when the number of active NICs varies with different packet sizes.

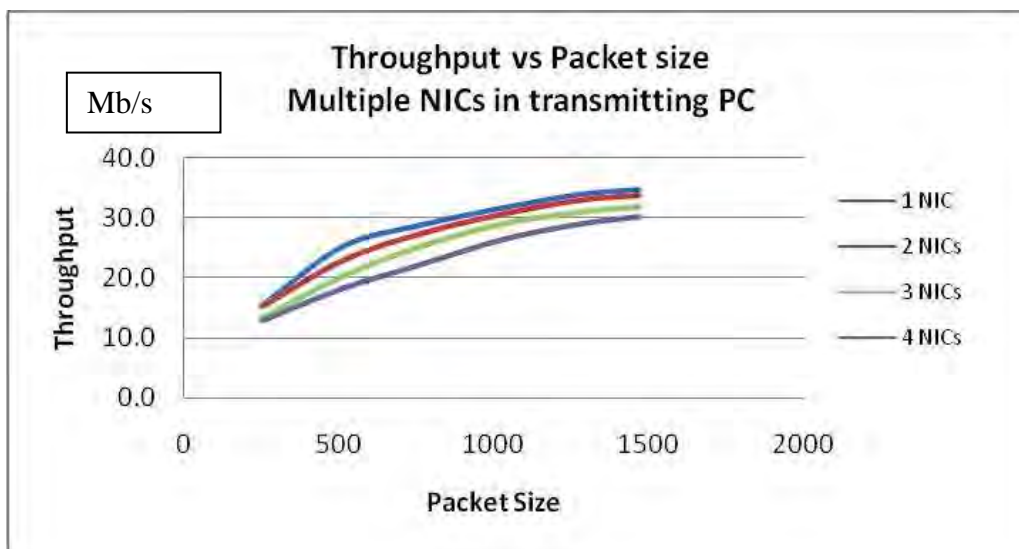

Figure 4.5: The variation in the aggregate node throughput under non-saturation conditions with multiple wireless cards and different packet sizes.

Figure 4.5 shows a graph of the results given in Table 4.1 and it shows that under non-saturation conditions, the throughput between the active pair decreases as more NICs are activated in the Tx node. Also it is worth pointing out that larger packet sizes also contribute to the increased throughput owing to more efficient use of the transmission medium.

Figure 4.6 below is a graph of the throughput and CPU idle % data collected during an experiment. This experiment measured the maximum possible throughput between the active pair as well as the CPU idle % value (by using the *top* command in the linux system). These measurements were then repeated after additional NICs were inserted into the testbed. The results show the effect of each additional NIC on throughput with reference to the CPU idle %. Again the experiment was conducted under non-saturation conditions.

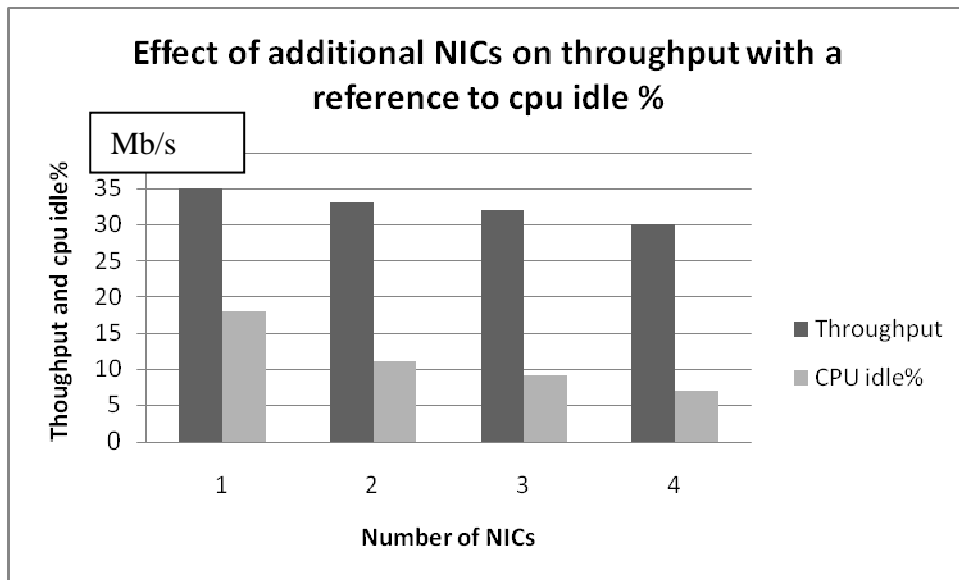

Figure 4.6: Effect of additional NICs on throughput under non-saturation with a packet size of 1470 bytes.

Table 4.1 and Figures 4.5 and 4.6 indicate that when the network is not saturated and provided that there is sufficient CPU processing power, the throughput between the active pair decreases as the number of NICs increase. As expected when given a fixed number of radios in a node, the throughput between the pair increases when using larger packet sizes owing to more efficient use of the transmission medium. It should be emphasized that each additional NIC card has been placed in a monitor (passive) state, and therefore each additional NIC imposes an additional load on the CPU as every frame on the medium is monitored by these additional NICs and hence requires servicing by the CPU.

4.2.2 Throughput measurements under saturation condition at the Tx node

This section presents data collected during the experiments conducted when the network is fully saturated, and the testbed is setup as described in Section 3.3.2. Figure 4.7 below is the result from an experiment where the network is fully saturated and the impact of inserting an additional NIC on the active pair throughput and the CPU idle % can be seen.

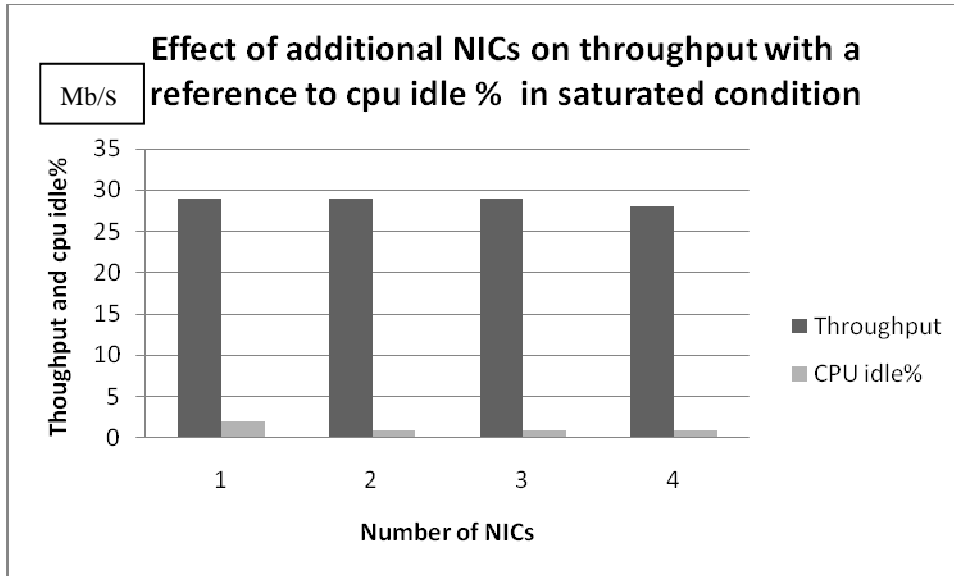

Figure 4.7: Throughput statistics under saturation condition with reference to CPU idle % for a packet size of 1470 bytes .

It can be observed from Figure 4.7 that when the network is fully saturated, additional NICs inserted into the system do not have any discernable impact on either the throughput performance or the CPU idle %.

As the Madwifi driver is able to provide different operation modes for the NICs, an experiment was performed to investigate the impact of using two different modes, i.e. the AP and Monitor modes, under saturation condition. The results from this experiment are shown in Figure 4.8 below and show that additional NICs do not have a significant impact on the throughput performance.

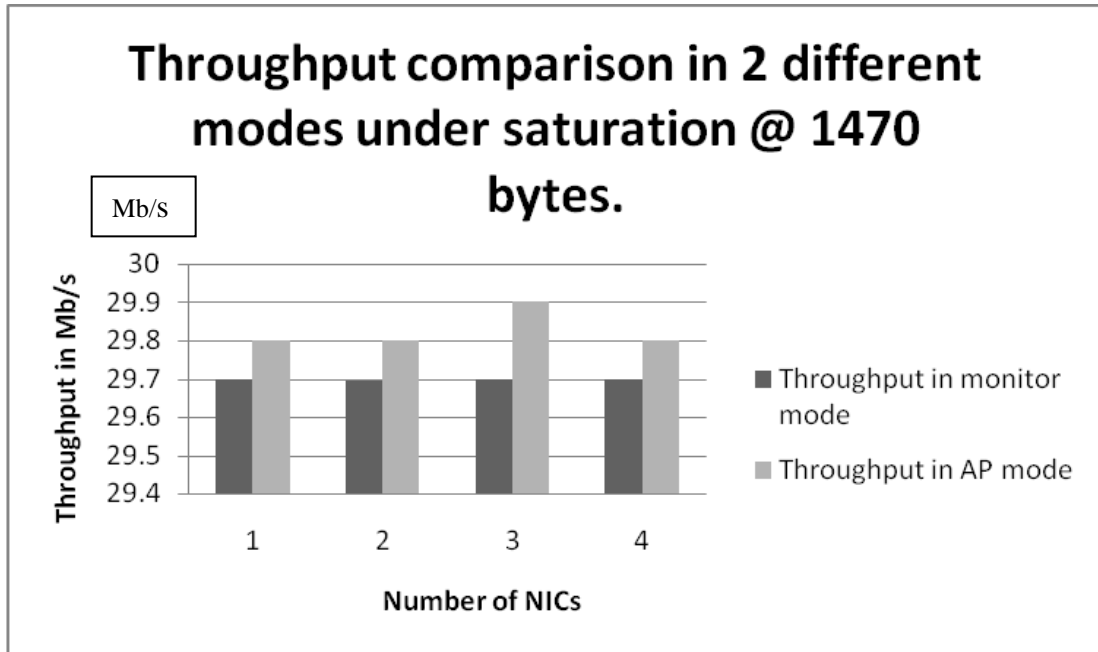

Figure 4.8: Throughput comparison in 2 different modes under saturation with 1470 bytes packets.

During this phase of the experiment, the D-ITG tool sets are used to generate large amounts of UDP traffic in order to fully saturate the network and the CPU processing power of the receiving node. The packets are 1470 bytes in size and are created at the rate of 5000 packets per second. From an analysis of the data carried out after the experiments, it was observed that the CPU idle% had been less than 1% throughout the tests.

Furthermore, Figure 4.7 shows that the throughput does not vary when additional NICs are inserted, which is contrary to the result for the non-saturation experiment presented in Figure 4.7. This result confirms the observation made in Section 4.2.1 that the decrease in throughput is primarily due to the finite processing power of the node. In other words, the crosstalk does not appear to be a limiting factor in determining the maximum achievable throughput. Figure 4.8 shows the throughput

comparison when the additional NICs are set to the Monitor mode and the AP mode under saturation conditions. There is a slight increase in throughput when using the AP mode which is due to the fact that AP mode does not require as much CPU resources when compared to the Monitor mode.

4.2.3 Experiments at the Rx node

This section presents the results from an experiment to investigate the impact of using different operating modes, transmission power, and link quality on the saturated throughput between the active pair.

As shown in Table 4.2 below, different test scenarios were created for an increasing number of active NICs. When additional NICs are inserted into the node, the signal level, throughput and link quality are measured for several operating modes with different power output levels.

Signal Level (dBm)	Noise Level (dBm)	Saturated Throughput (Mbps)	Link Quality	No. of active NICs @ RX	Modes
-46	-84	29.7	40/70	1	adhoc
-46	-84	29.5	38/70	2	adhoc
-51	-91	29.5	38/70	2	monitor
-38	-84	29.6	45/70	2	inactive
-50	-85	29.6	35/70	2	adhoc+10mw
-54	-84	29.4	30/70	2	adhoc+5mw
-64	-86	16.7	22/70	2	adhoc+1mw
-51	-91	29.4	40/70	3	adhoc
-51	-91	29.6	40/70	3	monitor
-48	-91	29.7	43/70	3	inactive
-56	-92	29.6	36/70	3	adhoc+10mw
-60	-92	29.5	32/70	3	adhoc+5mw
-66	-93	29.2	27/70	3	adhoc+1mw
-55	-92	29.3	37/70	4	adhoc
-56	-93	29.4	36/70	4	monitor
-51	-93	29.6	42/70	4	inactive
-60	-93	29.5	33/70	4	adhoc+10mw
-65	-93	29.6	29/70	4	adhoc+5mw
-71	-93	14.8	22/70	4	adhoc+1mw

Table 4.2 Results recorded at the Rx node under different test scenarios (link quality is obtained directly from the madwifi *ifconfig* command)

From Table 4.2 above, several observations can be made as follows:

1. Both the signal level and noise level decreases when the number of active NICs at the Rx node increases.
2. When the additional NICs are placed in the inactive mode, it can be observed that the signal level increases as well as the link quality. There is also a slight increase in the throughput.

3. There is no significant change in the throughput when additional NICs are inserted into the Rx node.
4. There is no major difference in throughput between the various operating modes.
5. A significant decrease in throughput can be observed when the Tx transmitting power is set to its minimum value.
6. The throughput increases with link quality improves.

In summary, despite the variations in signal levels and link quality, additional NICs inserted into the node do not seem to produce a negative impact on throughput performance.

4.3 Cabled Multi Radio Testbed

4.3.1 Experiments to determine the weighting factors

This section of experiments is concerned with finding the weights for each of the metrics used in the combined function model. Table 4.3 below presents the recorded values of *PER* when various combinations of *Line Rate*, *RSSI* and *Contention* are used.

<i>PER</i> (%)	<i>LR</i> (Mbps)	<i>Contention</i> (n)	<i>RSSI</i> (dBm)
0.7	47	2.5	8
0.62	45	2.1	16
0.55	42	1.8	20
0.39	35	1.5	28
0.25	29	1.2	35
0.17	25	0.8	38
0.15	22	0.7	39
0.12	16	0.6	41
0.1	12	0.3	43

Table 4.3 Recorded values of *PER* when different metric combinations were used.

As discussed in the previous chapter, in order to use the multiple linear regression model to determine the different weightings for the metrics, it is necessary to plot the *PER* against each of the metrics to determine the nature of the relationship.

The results contained in the figure below are from an experiment where the *contention* value and the *PER* are measured simultaneously when the data is being sent from one node to another.

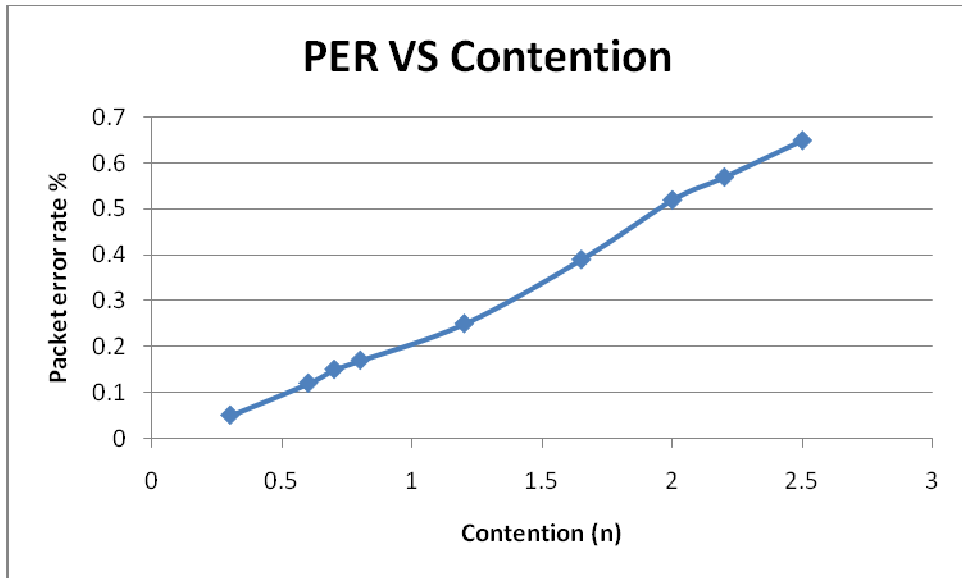

Figure 4.9: Plot of *PER* against *Contention* values.

In Figure 4.9 one can observe an almost linear relationship between the *PER* and the *Contention* values.

Figure 4.10 below shows the result from a similar experiment that illustrates the relationship between the *RSSI* value and the *PER*.

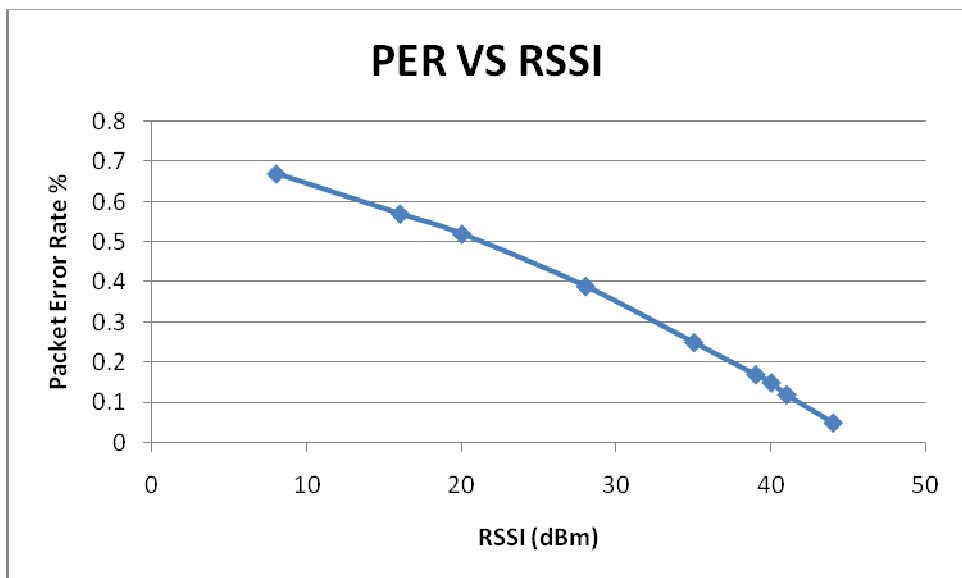

Figure 4.10: Plot of *PER* against *RSSI* values.

Again, one can observe a log relationship between the *PER* and the *RSSI* values, for the sake of simplicity, it is treated as a near linear relationship in the later discussions.

Similarly, Figure 4.11 below presents the measurements for *PER* and *Line Rate*.

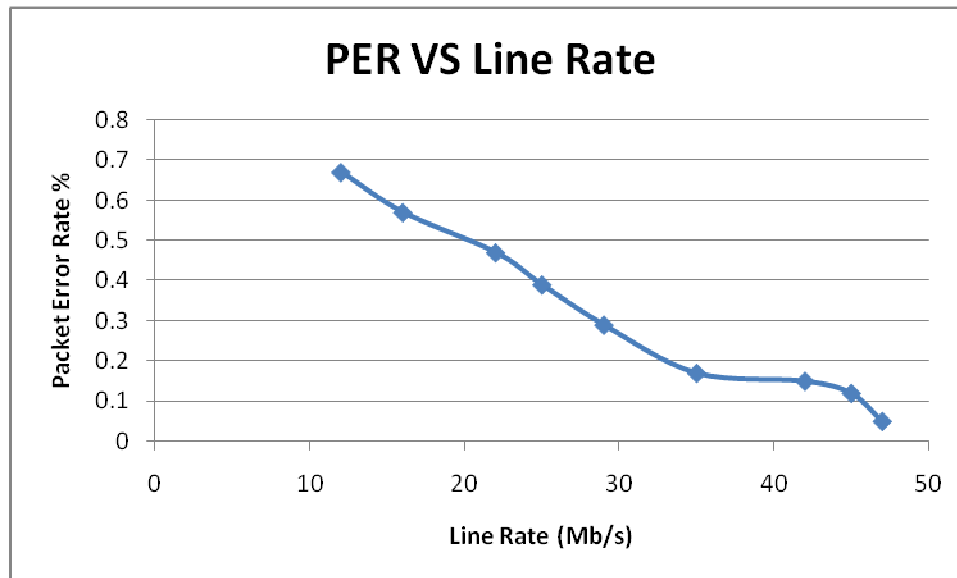

Figure 4.11: Plot of *PER* against *Line Rate* values.

Theoretically, one would expect that higher *Line Rate* values will result in higher *PER* values. From the results in Figure 4.11 one can observe that the relationship is not linear between the *PER* and the *Line Rate* values. The reasons for this are: Firstly, the *PER* values are a result of different performance metrics. In other words, the *Line Rate* is not the sole determining element in the combined function. Secondly, as explained in Chapter 3 and shown in Table 3.2, modulation schemes have an impact on the *PER* that cannot be neglected. QAM is used for line rate values between 24Mbps and 54Mbps. As can be seen in Figure 4.11, when the Line Rate values reaches 36Mbps and above, the shape of the plot becomes non-linear corresponding to the change in the modulation scheme used.

Following on from the discussion of the three figures above and for sake of simplicity, it is reasonable to approximate the relationship between the three metrics as a linear relationship. Therefore, the next step is to utilize a multiple linear regression model (which was discussed earlier in chapter 3) to determine the coefficients for the desired combined function.

As outlined earlier, the objective of this section is to determine the different weights that each parameter carries in the combined function. Below are the weights calculated based on the data from Table 4.3 by using the multiple linear regression method.

<i>Line Rate (Mbps)</i>	0.006
<i>Contention(Arbitrary Unit)</i>	0.089
<i>RSSI(dBm)</i>	0.018
<i>Constant(Arbitrary Unit)</i>	0.08

Table 4.4 The coefficients and the constant of the combined function model.

From the results shown in Table 4.4 above, the combined function model is as follows:

$$PER = LineRate \times 0.006 + Contention \times 0.089 + RSSI \times 0.018 + 0.08 \quad (4.2)$$

Since the weightings for the various passive metrics that comprise the combined function have been determined, the next step is to validate the accuracy of this

approach. The table below contains data collected during an experiment where a multi-radio node was set up to transmit packets to another multi-radio node with different combinations of *LineRate*, *Contention* and *RSSI*. The predicted *PER* is firstly calculated by using the proposed function, and then it is compared with the actual *PER* which is collected by using the software introduced in chapter 3.

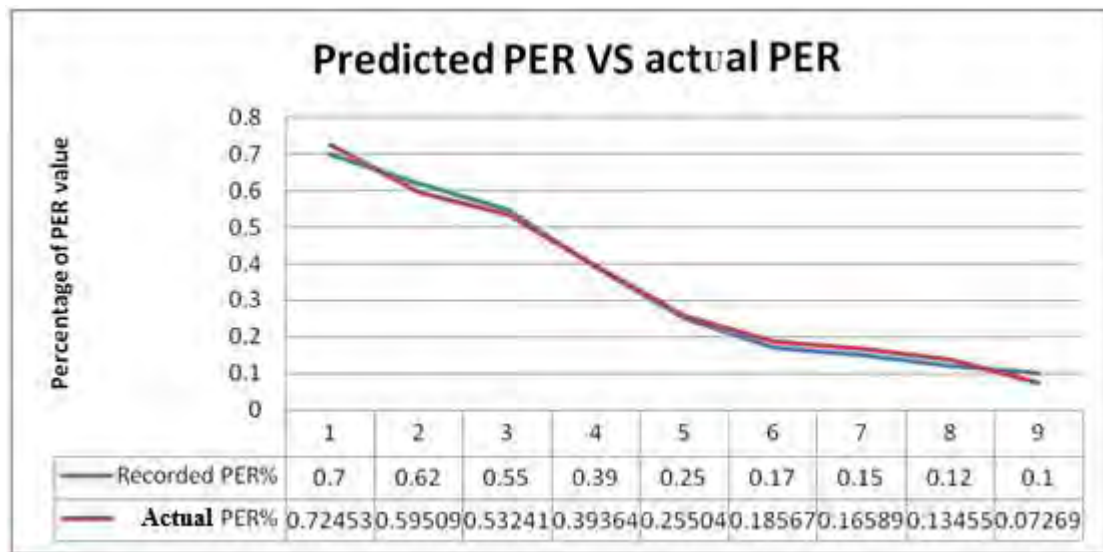

Table 4.5 The percentage error difference between the *PER* value predicted by the combined function model and the actual *PER*.

As can be observed in Table 4.5, the accuracy of the proposed combined model is within a few percentage of that produced by the active probing technique.

To further verify the correlation between the passive combined function model and the active direct method, the *Pearson Correlation Coefficients* for these two data sets were calculated in a real test bed scenario. During the course of the experiment the *PER* value and the *combined function* values were recorded and calculated every 20 seconds. Finally, the *Pearson Correlation Coefficient* was calculated based on these two data sets. The figures below present these findings from 40 experimental cases.

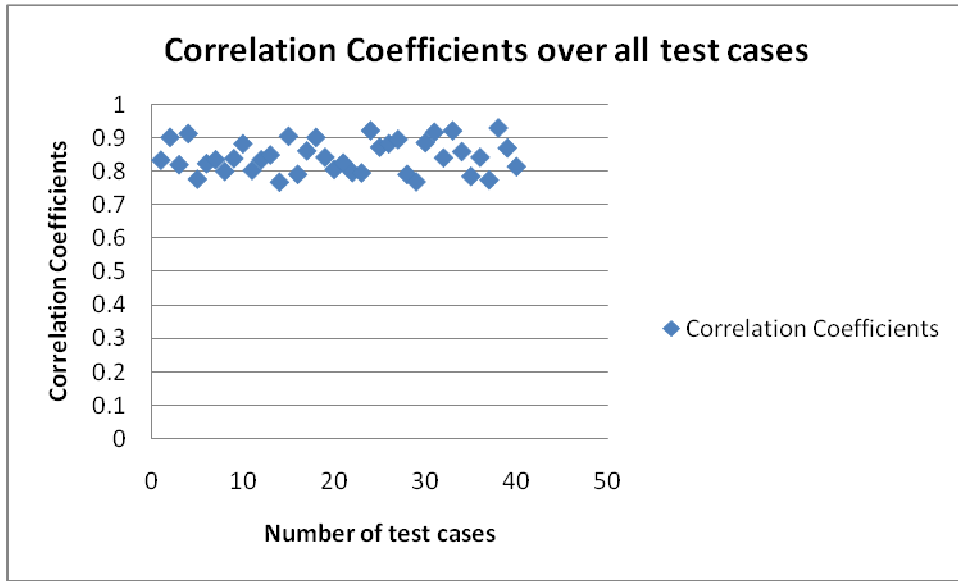

Figure 4.12: Pearson correlation coefficients over 40 test cases.

As shown above in Figure 4.12, the correlation between the combined function values and the *PER* values is high. This is an indication of the high correlation of the passive monitoring technique and the active probing method in multi-radio WLAN networks.

4.4 Summary

This section presents the summary of the experimental findings by following a progression from single radio experiments to multi-radio experiments and from a non-saturated condition to a saturated condition. The ultimate goal of the thesis is to investigate the feasibility of using passive monitoring technique in a multi-radio wireless network. As discussed in chapters 2 and 3, there were three sets of experimental investigations performed to achieve this goal. A summary of each experimental investigation is given below:

The first experimental investigation studied the effectiveness of the passive monitoring technique when compared with the traditional active probing method in a single radio network. This serves as the starting point that will lead towards the multi-radio goal. During the experiments, it was observed that by combining certain passively obtained metrics, the passive monitoring technique yields a high correlation with the active probing method.

The second experimental investigation was concerned with the operating characteristics of multi-radio networks. During these experiments, the impact of using multiple radios in a network was studied under both non-saturated and fully saturated conditions. It was found that when the network was not saturated, the capacity increases as a function of the number of NICs. But under saturation, it would appear that the additional NICs do not produce any benefit in terms of improved network performance. The system throughput degradation was also investigated where it was found that the limited CPU resources of the computer platform used is the main cause of the performance degradation.

Having studied the performance of the passive monitoring technique in single radio networks and the operating characteristics of the multi-radio networks, the next step was to test the feasibility of using such a technique in a multi-radio network. By proposing the use of a combined function composed of passively obtained metrics, it was shown through the experiment results that such a technique yields an accurate measurement of *PER* when compared with the active probing method.

5 Conclusions

As the use of wireless mesh networks (WMNs) continues to become more widespread, it seems likely that the deployment of real-time applications on these networks will also increase. Applications such as VoIP and VOD will continue to drive the need for improved capacity in multi-radio networks. In mesh networks improved monitoring techniques are vital for the support of highly effective route selection mechanisms to realize higher capacities.

This thesis presents a detailed experimental analysis of a passive monitoring technique for use in WMNs. In this technique all transmissions are passively intercepted and subsequent processing produces useful performance metrics such as *line rate*, *contention* and *RSSI* etc. It has the advantage that it does not generate any overhead unlike the continuous transmission of probe packets by the active probing techniques. The proposed technique is examined by comparing its accuracy with that of the active probing technique in both single-radio and multi-radio networks. The study shows that there is a high degree of correlation between these two techniques and that they can be used interchangeably. The performance impact of using multiple radios in a mesh node is also studied and it was found that the system performance degradation is caused by insufficient CPU resources. The addition of extra radios in a mesh node does not produce a discernible impact on the throughput under saturation condition. In order to realize an accurate substitute for the active probing technique, several passively gathered performance metrics were carefully chosen to form a combined function model. This was shown to produce an accurate estimate of the packet error rate (*PER*).

5.1 Findings of this Work

The WLAN Resource Monitor (WRM) application was used in this work to generate the passive network performance metrics. It operates non-intrusively by passively monitoring the wireless transmissions on the medium and therefore does not in any way interfere with the normal flow of traffic on the network. It has the advantage that it does not generate any form of overhead as opposed to the active probing technique which sends probing packets to the network at a constant rate.

The first objective of this work was the literature review to establish the state-of-the-art regarding the measurement of link performance and the operation of routing selection mechanism in WMNs. This part of the work involved extensive reading and research on all relevant papers, journals and peer studies. The main findings from the literature review are as follows:

It has been found that since there may be a large number of nodes within a WMN, there may be as many different routes to choose from when forwarding a packet from one network node to another. The mechanism that controls the routes selection process is referred to as the routing protocol. Many different routing protocols have been developed and proposed for WMNs such as ADOV, DSR etc. The routing selection mechanisms of those routing protocols vary considerably. The routing protocols use link metrics as part of the path selection mechanism. As such, it is important to determine accurate performance metrics. Traditionally, researchers had been using the active probing method which although it generates overhead it is

considered an accurate and reliable method. Only recently has passive monitoring started to gain in popularity as a means to obtain network performance metrics. It has the advantage over the active probing methods that it does not impose any overhead on the network.

Based upon the findings from the literature review, the following questions arise: How accurate is passive monitoring compared to the active probing method? Can it replace the active probing method? Traditionally, routing protocols have used active performance metrics like hop count, ETT, packet loss rate etc. to establish the routing decision. This thesis focuses on the packet error rate (*PER*) in an attempt to develop a passive monitoring mechanism and these questions lead us to the next objective of this work.

The second objective of this work was to investigate the correlation of the passive monitoring and the active probing techniques in a single-radio WMN as a foundation for further research. A segment of our 17-node mesh network was chosen to be the experimental test bed for this purpose. The idea behind the experiments was to passively collect MAC layer performance metrics and at the same time to actively calculate the *PER* every 10 seconds. These experiments had a duration of at least 17 hours and generated two sets of data corresponding to each of the techniques used. The Pearson Correlation Coefficient was calculated for these two data sets and then plotted.

As shown in section 4.1 of this thesis, initially only one passive metric was chosen and its correlation with the *PER* was calculated. The results demonstrated that none of

these passively gathered performance metrics on their own were capable of producing a reliable and high correlation with the *PER* obtained through active probing. This indicated that a single passive metric is not sufficient to accurately determine the network performance. Therefore the next step in the experiment was to combine a number of passively obtained performance metrics in order to realize a higher correlation with the *PER* generated by the active probing method.

Subsequent experimental results revealed the feasibility of such a model as it yielded a stable correlation with the *PER* obtained using the active probing method. The findings of this section shows that by combining certain passively gathered performance metrics, the passive monitoring technique can be used to accurately estimate the *PER*. Moreover, this combined function model can well be used interchangeably with the active probing technique.

The third objective of this work was to study the characteristics of multi-radio wireless networks with regard to the throughput degradation problem associated with the simultaneous activation of multiple radios in a network node. The ultimate goal of this thesis is to determine the feasibility of using a passive monitoring technique instead of an active probing method in obtaining performance metrics for supporting routing in WMNs. Therefore, it is important to study the performance impact of using multiple radios in a network. In this thesis, the throughput between two multi-radio nodes under various test scenarios was examined. This part of the work is divided into two sections: the network performance under saturation conditions and the network performance under non-saturation conditions.

Under non-saturation conditions, it was observed that the overall capacity of a multi-radio node increases as a function of the number of active radios. The impact of each additional radio was examined with regard to the CPU idle %. Each experiment was repeated 5 times to obtain the average value of this metric in order to provide an indication of the computational load imposed on the CPU. Also when all of the additional radios were placed into the passive mode, it was observed that each additional radio would impose a 3-5% penalty on the CPU idle %. The reason was that although the radio card was placed in the passive mode, each frame in the medium is monitored by these radios and thus requires CPU servicing. This leads to the system performance degradation which was confirmed by the experimental results.

When the network is fully saturated, it was found that regardless of the number of the active radio cards within a station, the CPU processing power was fully consumed while the maximum achievable throughput of the station did not vary. We conclude that the so called “cross talk” (as suggested by other researchers in this area) between the active radio cards would not appear to be a limiting factor in determining the maximum achievable throughput. Instead the finite computing power available at the node was largely responsible for the system performance degradation problem associated with the simultaneous activation of multiple radios within a node.

Another set of experiments was carried out to study the impact on the link quality and throughput when using different operation modes and transmission powers. The following observations were made: Both the signal level and noise level decrease when the number of active radio cards at the Rx node increases and similar to the

previous experiments there is no significant change in the throughput when additional radio cards are inserted into the Rx node. Another interesting finding is that there is no major difference in throughput between the various operating modes and transmitting powers. Having said that, it was observed that the only exception to this was that there was a significant decrease in throughput when the transmission power is set to its minimum value as the power was too low to ensure reliable packet delivery. Having studied the performance characteristics of WMNs, the next step was to incorporate the passive monitoring technique into a multi-radio network.

The fourth objective of this work was to investigate the feasibility of using the passive monitoring technique in a multi-radio network. The term feasibility refers to a number of aspects here and its definition should be obtained from answering the following questions: In a multi-radio network, can the passive monitoring technique yield similar results to those obtained through the active probing method as observed in the single radio network? If so, can an accurate model be developed to estimate the active performance metric with passive performance metrics? What is the accuracy of such a model?

With these questions in mind, the first priority is to choose suitable passive performance metrics in order to establish a combined model. The inter-dependencies and the relationship of the many MAC bandwidth components were carefully studied and only the ones with the most direct relationship with the *PER* were chosen, namely *line rate*, *contention* and *RSSI*. The details of this selection process are explained in chapter 3.

Through a series of experiments it was found that each of these metrics has an almost linear relationship with the *PER*. It was clear that in order to accurately establish a combined function model, it was necessary to calculate the coefficients/weightings for the three metrics. This was done by using a multiple linear regression model which is described in chapter 3. Once the corresponding weightings were calculated, an expression was established in the form of (the units are: *linerate* in Mbps, *rssi* in dBm and *contention* is a dimensionless ratio):

$$PER = 0.006 * \textit{linerate} + 0.089 * \textit{contention} + 0.018 * \textit{rssi} + 0.08 \quad (5.1)$$

This equation can be used to estimate the active performance metric from the passive measurements.

It was also found that the line rate has the dominant effect on *PER* performance as indicated in chapter 4. Later this equation was validated in a multi-radio test bed as shown in earlier chapters. The results showed a small error difference between the estimated *PER* and the actual *PER* where the error was of the order of a few percent. Through a large number of experimental runs, the results demonstrated a high and stable correlation between the two methods which confirms the effectiveness of the passive monitoring technique in a multi-radio network and the inter-changeability of the two techniques.

5.2 Future Work

In this work, a novel method of estimating the active performance metrics through the use of passively obtained metrics in multi-radio networks has been proposed. Although this method has been shown to accurately estimate the *PER*, which is an important network performance indicator, further analysis of the scheme under different network and propagation conditions could be performed.

Regarding the wireless multi-radio testbed, only a single hop scenario was established and examined. It would be beneficial to implement and test this scheme within a multi-hop Wireless Mesh Network. In such networks, the contention for access will be greater which will have an impact of the *PER* estimate.

Another important concern in this work is that for the purposes of assessing its performance, the performance metric selected is the *PER*. Packet errors tend to arise from two sources, namely channel conditions and network conditions. The channel conditions involve AWGN, fading, interference etc. and the network conditions refers to collisions, retransmissions etc. Not surprisingly the passive monitoring technique is only able to track the changes in the network conditions, not the channel conditions. During the course of this work the channel conditions were kept relatively stable and therefore the main limitation of the proposed passive scheme is that it has not been applied to network deployments where there is an absence of LOS communication between nodes. Consequently, there will no longer be a simple linear relationship between the metrics. This will probably require the introduction of additional passive metrics into the combined function. Thus, it would be extremely beneficial to further

develop the proposed scheme to adapt to both channel and network conditions in the future.

Although the scheme presented in this thesis is quite limited as discussed above, the main contribution of this work is that it presents an important first step in the development of passively obtained performance metrics for supporting routing protocols in WMNs. It has demonstrated the feasibility of such an approach, i.e. that it is possible (in principle) to substitute active probing techniques with passive ones. Clearly, this thesis represents just the beginning of a whole new approach to obtaining efficient and accurate passive routing metrics for WMNs. There is considerably more work to be done in improving the accuracy and applicability of the technique. However, this is beyond the scope of this MPhil thesis and would be more appropriate to a PhD study.

Ultimately, the future works in this area will involve extensive experiments in outdoor and multi-hop networks where the accuracy of the proposed scheme can be further assessed. Depending on the outcome, additional passive metrics may need to be added, and also further mathematical analysis may be needed to investigate the correlation between the passive metrics and the channel interference such as fading etc. All of the above considerations will need to be incorporated into the proposed scheme to improve its accuracy under different deployment and channel conditions. As the proposed scheme is a means of monitoring the network performance, it makes sense to develop this scheme as a piece of monitoring software that will take account of both network and channel conditions and report the real-time network performance to the end users or feed it back into the monitoring application. Such software

application can also aid the path selection and subsequently, the routing selection process.

References

- [1] K.Kowalik, B.Keegan and M.Davis., "Making OLSR Aware of Resources." Shanghai, China: Wicom2007, August 2007.
- [2] MIT Roofnet. [Online] [Last checked: April 27, 2010.] <http://www.pdos.lcs.mit.edu/roofnet>.
- [3] Mesh networking summit. [Online] [Last checked: April 27, 2010.] <http://research.microsoft.com/meshsummit>.
- [4] Seattle Wireless. [Online] [Last checked: April 27, 2010.] <http://www.seattlewireless.net>.
- [5] Mesh Dynamics Inc. [Online] [Last checked: April 27, 2010.] <http://www.meshdynamics.com>.
- [6] R.Karrer, A.Sabharwal, and E.Knightly., "Enabling Large-scale Wireless Broadband: The case for TAPs." Cambridge, MA, USA: Hotnets, 2003.
- [7] S.Lee, S.Nanerjee, and S.Bhattacharjee., "The Case for a Multi-hop Wireless Local Area Network." HongKong, China: IEEE Infocom, March, 2004.
- [8] Portoles-Comeras, M. Mangues-Bafalluy, and J. Requena-Esteso., "Multi-radio Based Active and Passive Wireless Network Measurements." Boston, MA, USA: 4th International Symposium on Modelling and Optimization in Mobile, Ad Hoc and Wireless Networks, April 2006.
- [9] L. Ciavattone, A. Morton, and G. Ramachandran., "Standardized Active measurements on a tier 1 IP backbone." IEEE Comm. Mag., V4 i6, P90-97, June 2003.
- [10] Rappaport, Benjamin E. Henty and Theodore S., Throughput Measurements and Empirical Prediction Models for IEEE 802.11b Wireless LAN (WLAN) Installations. [Online] Technical Report MPRG 01-08, Dept. of Electrical and Computer Engineering, Virginia Polytechnic Institute and State University, 2001. [Last checked: April 27, 2010.] <http://scholar.lib.vt.edu/theses/available/etd-08142001-172523/unrestricted/hentythesis.pdf>.
- [11] J. Yeo, M. Youssef, T. Henderson, and A. Agrawala., "An accurate technique for measuring the wireless side of wireless networks." Seattle, WA, USA: WiTMeMo '05, June 2005.
- [12] A. Willig, M. Kubisch, C. Hoene, and A. Wolisz., "Measurements of a wireless link in an industrial environment using an IEEE 802.11-compliant physical layer." IEEE Transactions on Industrial Electronics, December 2002, Issue no. 6, pp. 1265-1282, Vol. 43.
- [13] G. Nguyen, R. H. Katz, B. Noble, , and M. Satyanarayanan., "A trace-based approach for modeling wireless channel behavior." Coronado, CA, USA: Winter Simulation Conf, December 1996.
- [14] M. V. Clark, K. K. Leung, B. McNair, and Z. Kostic., "Outdoor IEEE 802.11 cellular networks: Radio link performance." New York, USA: IEEE ICC 2002, April 2002.
- [15] Na, Chen., IEEE 802.11 Wireless LAN Traffic Analysis: A Cross-layer approach. [Online] PhD thesis dissertation, the university of Texas at Austin, May 2005. [Last checked: April 27, 2010.] <http://gradworks.umi.com/31/76/3176313.html>.

- [16] Marc Portoles-Comeras, Manuel Requena-Esteso, Josep Mangués-Bafalluy., "Monitoring wireless networks: performance assessment of sniffer architectures." Chicago, USA: IEEE ICC, June 2006.
- [17] J. Yeo, M. Youssef, T. Henderson, and A. Agrawala., "An accurate technique for measuring the wireless side of wireless networks." Seattle, WA, USA: WiTMeMo '05, June 2005.
- [18] J. Yeo, S. Banerjee and A. Agrawala., Measuring traffic on the wireless medium: experience and pitfalls. [Online] December 2002. [Last checked: April 27, 2010.] <http://www.cs.umd.edu/Library/TRs/CS-TR-4421/CS-TR-4421.pdf>.
- [19] J. Yeo, M. Youssef, A. Agrawala., "A Framework for Wireless LAN Monitoring and its Applications." Philadelphia, PA, USA: ACM MobiCom 2004, October 2004 .
- [20] D. Aguayo, J. Bicket, S. Biswas, G. Judd, and R. Morris., "Link-level measurements from an 802.11 b mesh network." Portland, USA: ACM SIGCOMM, Aug 2004. pp. 121–132.
- [21] D.Kotz, C. Newport, R. S. Gray, J. Liu, Y.Yuan, and C. Elliott., Experimental evaluation of wireless simulation assumptions. [Online] Dept. of Computer Science, Dartmouth College, Tech., 2004. [Last checked: April 27, 2010.] www.ists.dartmouth.edu/library/45.pdf. Rep. TR2004-507.
- [22] Haykin, S., "Cognitive radio: Brain-empowered wireless communications." IEEE J. Sel. Areas Commun., Feb 2005, Issue no. 2, pp. 201–220, Vol. 23.
- [23] D. S. D. Couto, D. B. Aguayo, A. Chambers, and R. Morris., "Performance of multi-hop wireless networks: Shortest path is not enough." Princeton, NJ, USA: HotNets-I, Oct 2002.
- [24] Morris, S. Biswas and R., "ExOR: Opportunistic multi-hop routing for wireless networks." Philadelphia, PA, USA: ACM SIGCOMM, Aug 2005.
- [25] Morris, S. Biswas and R., "Opportunistic routing in multi-hop wireless networks." Cambridge, MA, USA: HotNets-II, Nov 2003.
- [26] C. Yu, K. G. Shin, and L. Song., "Link-layer salvaging for making routing progress in mobile ad hoc networks." Urbana-Champaign, IL, USA: ACM MobiHoc, May 2005.
- [27] R. Draves, J. Padhye, and B. Zill., "Routing in multi-radio, multi-hop wireless mesh networks." Philadelphia, PA, USA: ACM MobiCom, Sep. 2004.
- [28] D. S. D. Couto, D. Aguayo, J. Bicket, and R. Morris., "A high-throughput path metric for multi-hop wireless routing." San Diego, CA, USA: ACM MobiCom, Sep. 2003.
- [29] L. Qiu, P. Bahl, A. Rao, and L. Zhou., "Troubleshooting multi-hop wireless networks." Alberta, Canada: ACM SigMetrics, Jun. 2005.
- [30] D. D. Clark, C. J. Partridge, C. Ramming, and J. T. Wroclawski., "A knowledge plane for the Internet." Karlsruhe, Germany: ACM SigComm, Aug. 2003.
- [31] S. Lee, B. Bhattacharjee, and S. Banerjee., "Efficient geographic routing in multihop wireless networks." Urbana-Champaign, IL, USA: ACM MobiHoc, May 2005.
- [32] P. Bahl, R. Chandra, and J. Dunagan., "SSCH: Slotted seeded channel hopping for capacity improvement." Philadelphia, PA, USA: ACM MobiCom, Sep. 2004.
- [33] Chiueh, A. Raniwala and T., "Architecture and algorithms for an IEEE 802.11b based multi-channel wireless mesh network." Miami, FL, USA: IEEE InfoCom, Mar. 2005. pp. 2223–2234.

- [34] Multiband Atheros driver for WiFi. [Online] [Last checked: April 27, 2010.] <http://madwifi.org/>.
- [35] C. Dovrolis, P. Ramanathan, and D. Moore., "What do packet dispersion techniques measure." Anchorage, AK, USA: IEEE InfoCom, Apr. 2001. pp. 905–914.
- [36] Downey, A. B., "Using pathchar to estimate Internet link characteristics." Cambridge, MA, USA: ACM SigComm, Sep. 1999. pp. 241–250.
- [37] Hedrick, C., Routing information protocol. *Internet Request for Comments 1058*. [Online] 1988. [Last checked: April 27, 2010.] <http://www.ietf.org/rfc/rfc1058.txt>.
- [38] Moy, J., OSPF version 2. *Internet Request for Comments 2328*. [Online] 1998. [Last checked: April 27, 2010.] <http://www.rfc-editor.org/rfc/rfc2328.txt>.
- [39] Maltz, D. B. Johnson and D. A., *Dynamic source routing in ad hoc wireless networks*. Norwell, MA, USA: Kluwer, 1996. 0071477330.
- [40] C. Perkins, E. Belding-Royer, and S. Das., Ad-hoc on-demand distance vecto. *Internet Request for Comments 3561*. [Online] 2003. [Last checked: April 27, 2010.] <http://www.ietf.org/rfc/rfc3561.txt>.
- [41] T. Goff, N. B. Abu-Ghazaleh, D. S. Phatak, and R. Kahvecioglu., "Preemptive routing in ad hoc networks." Long Beach, CA, USA: ACM MobiCom, Jul. 2001. pp. 43–52.
- [42] C. Ho, K. Ramachandran, K. Almeroth, and E. Belding-Royer., "A scalable framework for wireless network monitoring." Philadelphia, PA, USA: ACM WMASH, Oct. 2004.
- [43] M.Ye, W.Wu and X.Xu., "MR Mesh: A Multi-Radio Wireless Mesh Network Testbed." Dalian, China: Wicom08, Oct 2008.
- [44] J. Robinson, K. Papagiannaki, C. Diot, X. Guo, L. Krishnamurthy., "Experimenting with a Multi-Radio Mesh Networking Testbed." Trentino, Italy: WinMee'05, Apr. 2005.
- [45] A. Adya, P. Bahl, J. Padhye, A. Wolman, and L. Zhou., "A multi-radio unification protocol for IEEE 802.11 wireless networks." San Jose, CA, USA: Broadnets, Oct 2004.
- [46] H. Lundgren, E. Nordstrom, and C. Tschudin., "Coping with communication gray zones in IEEE 802.11b based ad hoc networks." Atlanta, Georgia, USA: ACM WoWMoM Workshop, September 2002.
- [47] M. Yarvis, W. Conner, L. Krishnamurthy, J. Chhabra, B. Elliott, and A. Mainwaring., "Real-world experiences with an interactive ad hoc sensor network." Boston, MA, USA: the International Workshop on Ad Hoc Networking, August 2002.
- [48] D. De Couto, D. Aguayo, J. Bicket, and R. Morris., "A high-throughput path metric for multi-hop wireless routing." San Diego, CA, USA: ACM MobiCom , Sep. 2003.
- [49] Hay, Roger., An Introduction to Mesh Networking. [Online] April 2006. [Last checked: April 27, 2010.] http://home.cogeco.ca/~rmhay/WirelessMeshIntro_20060312.pdf.
- [50] Yuan Sun, Irfan Sherif, Elizabeth M. Belding-Royer and Kevin C. Almeroth., "An Experimental Study of Multimedia Traffic Performance in Mesh Networks." Seattle, WA, USA: MobiSys, Jun. 2005.
- [51] Davis, Mark., "A Wireless Traffic Probe for Radio Resource Management and QoS Provisioning in IEEE 802.11 WLANs." Venice, Italy: MSWiM'04, Jun. 2004.

- [52] Ramin Khalili, Kave Salamatian., Evaluation of packet error rate in wireless networks. [Online] 2004. [Last checked: April 27, 2010.] <http://www-rp.lip6.fr/~khalili/pub/mswim2004.pdf>.
- [53] Brian Keegan, Karol Kowalik and Mark Davis., "Experimental Measurement of Overhead Associated with Active Probing of Wireless Mesh Networks." Dubai: ICSPC07, Nov. 2007.
- [54] J.Benesty, J.Chen, Y.Huang, I.Cohen., "Pearson Correlation Coefficient." *Noise Reduction in Speech Processing*. Springer Berlin Heidelberg, ISBN: 978-3-540-49125-5.
- [55] Pcap Library. [Online] [Last checked: April 27, 2010.] <http://www.tcpdump.org>.
- [56] Davis, Mark., Wlan Resource Monitor. [Online] [Last checked: April 27, 2010.] <http://www.cnri.dit.ie/research.wrm.html>.
- [57] Soekris net 4521. [Online] [Last checked: April 27, 2010.] <http://www.soekris.com/net4521.htm>.
- [58] CNRI Mesh Testbed. [Online] [Last checked: April 27, 2010.] <http://www.cnri.dit.ie/research.mesh.testbed.html>.
- [59] Wetteroth, Debra., *OSI Reference Model for Telecommunications*. s.l. : McGraw-Hill Professional, 2001. ISBN: 0071380418.
- [60] Goransson, Paul and Greenlaw, Raymond., *Secure Roaming in 802.11 Networks*. Newnes, 2007. ISBN-10: 0-7506-8211-6.
- [61] Mark Davis, Tristan Raimondi., "A Novel Framework for Radio Resource Management in IEEE 802.11 Wireless LANs." Italy: WiOpt'05, Apr. 2005.
- [62] WireShark. [Online] [Last checked: April 27, 2010.] http://www.wildpackets.com/products/network_analysis/omnipeek_network_analyzer

List of Publications

1. “An Investigation of the Correlation between Passive Monitoring and Active Probing Techniques Used in WLAN Mesh Networks,” in Information Technology and Telecommunications Conference 2008 (ITT 2008), Galway Mayo Institute of Technology, October 2008.
2. “An Experimental Study of the Impact of Using Multi-Radio in WLAN Mesh Networks Wireless,” in 5th International Conference on Communications, Networking and Mobile Computing. (WiCom '09). 24-26 Sept. 2009 Beijing, China.