



2007-09-04

ANALYSIS OF A VARIABLE SPEED DOUBLE-FED INDUCTION GENERATOR WIND TURBINE DURING NETWORK VOLTAGE UNBALANCE CONDITIONS.

Joseph Kearney

Dublin Institute of Technology, joseph.kearney@dit.ie

Michael Conlon

Dublin Institute of Technology, Michael.Conlon@dit.ie

Follow this and additional works at: <http://arrow.dit.ie/engscheleart>



Part of the [Electrical and Electronics Commons](#), and the [Power and Energy Commons](#)

Recommended Citation

Kearney, Joseph and Conlon, Michael, "ANALYSIS OF A VARIABLE SPEED DOUBLE-FED INDUCTION GENERATOR WIND TURBINE DURING NETWORK VOLTAGE UNBALANCE CONDITIONS." (2007). *Conference papers*. 219.

<http://arrow.dit.ie/engscheleart/219>

This Conference Paper is brought to you for free and open access by the School of Electrical and Electronic Engineering at ARROW@DIT. It has been accepted for inclusion in Conference papers by an authorized administrator of ARROW@DIT. For more information, please contact yvonne.desmond@dit.ie, arrow.admin@dit.ie, brian.widdis@dit.ie.



ANALYSIS OF A VARIABLE SPEED DOUBLE-FED INDUCTION GENERATOR WIND TURBINE DURING NETWORK VOLTAGE UNBALANCE CONDITIONS.

Joseph Kearney and Michael F Conlon
Dublin Institute of Technology, Ireland

ABSTRACT

The behaviour of Double-Fed Induction Generators to supply network voltage unbalance is investigated. The paper shows the effects that voltage unbalance can have on a DFIG, using Matlab/Simulink. The results from simulations show that voltage unbalance affects both the induction generator and the rotor converter, due to the high unbalanced currents generated. The ability to modify the control strategy of a DFIG to compensate for voltage unbalance is outlined and simulations show the improvements to the performance of the DFIG.

Keywords: Power Quality, Wind Power, Voltage Unbalance, DFIG

INTRODUCTION

Usually the most productive sites for the development of wind turbines and wind farms are in remote rural areas where distribution networks can be weak and voltage unbalance can be a common feature. This is certainly the case in Ireland where the majority of the wind energy developments have been on the north and west coast of the island [1]. This is also the region in which the transmission and distribution network is weakest.

Problems of power quality can arise with regard to the connection of embedded generation, including wind generation. On weak networks, the connection of wind generation can give rise to voltage fluctuations, including flicker and voltage control [2]. At the same time, power quality problems inherent to the network can cause difficulties with regard to the connection of wind generation. In the event of voltage depressions in the vicinity of system faults, wind generators can experience difficulties in remaining connected; the voltage ride-through problem [2]. Voltage unbalance can also give rise to excessive unbalanced stator currents in wind generators, causing generators to trip out. The authors have monitored the voltage unbalance at a small wind farm in County Cavan in the Republic of Ireland over an extended period and have gained an insight into the extent and variability of voltage unbalance experienced by wind generation.

This paper looks specifically at the behaviour of a double-fed induction generator (DFIG) in response to a voltage unbalance introduced into the network to which it is connected. Matlab/Simulink is used to model and simulate a DFIG and the behaviour of the induction generator and the grid/rotor converters is investigated.

SIMULATION STUDY

Induction generators subjected to network voltage unbalance can overheat due to the excessive currents, and mechanical stress can occur due to torque pulsations. The rotor converter in a DFIG is also susceptible to high currents during periods of voltage unbalance.

The DFIG wind turbine in this study is modelled in Matlab/Simulink [3] to analyse the behaviour of both the induction generator and rotor converter to grid network voltage unbalance. The rotor converter in particular is analysed during network voltage unbalance conditions. The system under investigation is shown in Fig. 1. The network to which the DFIG is connected is represented by a constant voltage and a distribution line with a length of 30 km. The line series resistance is $0.115 \Omega/\text{km}$ and the reactance is $0.33 \Omega/\text{km}$. The distribution line is operated at a voltage of 25kV. The fault level at Bus A in Figure 1 is 10 MVA. The DFIG is connected via a 25kV/690V three-phase transformer. The generator rotor is connected to the grid side via a rotor converter, a dc bus [1.2 kV] and a grid side converter. The DFIG has a total rating of 1.5MVA, and for a speed variation of 30% the rotor converter has a rating 30% of the induction generator.

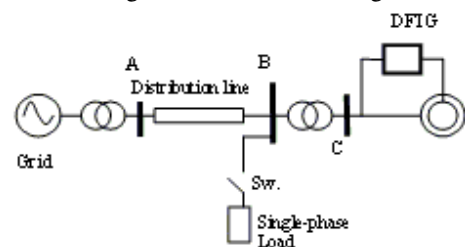

Figure 1 DFIG and Network Model

As shown in Fig. 1, a single-phase load of 6 MVA is supplied at bus B. This single-phase load introduces a voltage unbalance of 9% at Bus B. The voltage unbalance is expressed as the ratio of the negative sequence voltage to the positive sequence voltage [4].

SIMULATION OF VOLTAGE UNBALANCE

Initially the effect of the voltage unbalance on the stator of the generator is considered. Under network voltage unbalance conditions a negative phase sequence component occurs. Fig. 2 shows the instantaneous voltage and generated current at Bus C (Fig. 1) predicted by the Matlab/Simulink simulation. The single-phase load is switched-in at 0.35 seconds and introduces a voltage

unbalance. Clearly, the current is significantly unbalanced after this time.

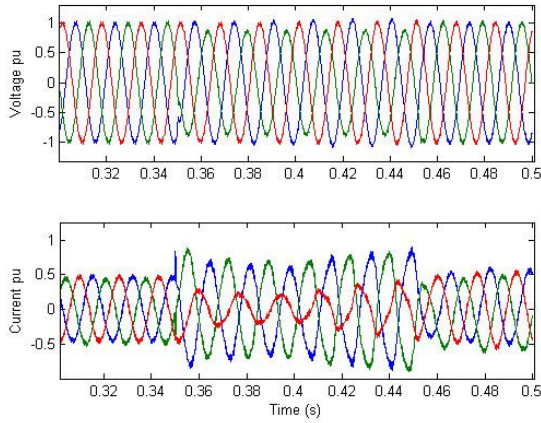

Figure 2 Stator Current

Although the voltage unbalance factor is approximately 9%, the accompanying negative sequence current unbalance factor is about 30%, as shown in Fig 3. As described in [4], this is because the negative sequence impedance of an induction generator is considerably lower than the positive sequence impedance at normal operating slip speeds.

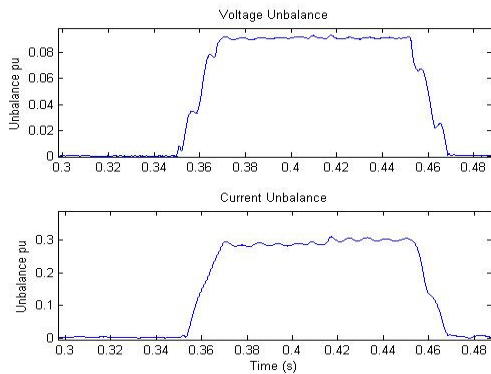

Figure 3 Stator Voltage and Current Unbalance

Investigations into voltage unbalance and sag conditions in a variable speed drive incorporating a PWM converter was evaluated by [8]. Some of the conclusions reached are that current unbalance can be up to 100% for an input voltage unbalance of only 5%. Fig. 4 is a plot of the voltage and current unbalance at the DFIG grid-side converter. For voltage unbalance of 9% the current is approximately 22% unbalanced.

POWER AND TORQUE PULSATIONS

The persistence of an unbalanced voltage condition presents serious problems to induction generators. Under

network voltage unbalance conditions a negative phase sequence occurs, which can result in power and torque oscillations.

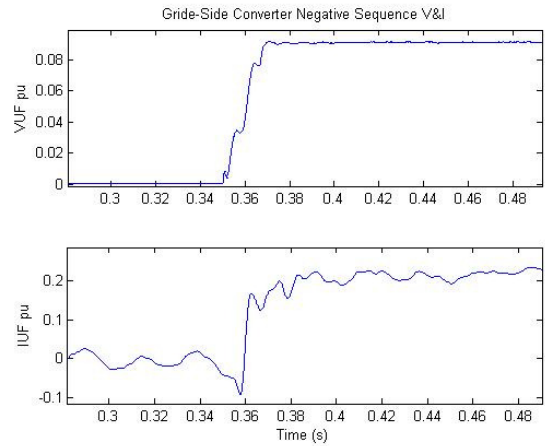

Figure 4 Grid-Side Converter Voltage and Current Unbalance

Fig. 5 shows the results of the Matlab/Simulink simulation on the 1.5 MW DFIG with voltage unbalance occurring after 0.35 seconds. Power pulsations can clearly be observed at the stator connection of the DFIG due to network voltage unbalance of 9%.

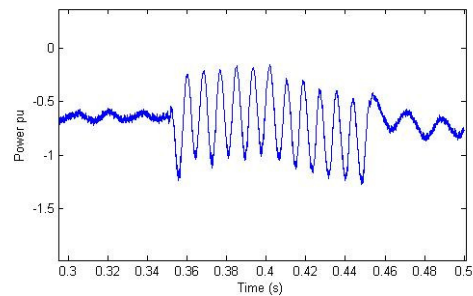

Figure 5 Power Pulsations on DFIG Due to Network Voltage Unbalance

When using symmetrical components, a separate equivalent circuit can be obtained for positive and negative sequence components [4].

The positive and negative sequence torques are:

$$T_1 = \frac{P_1}{\omega_m} = \frac{P_1}{\omega_s(1-s)} = \frac{3I_{1r}^2 R_r}{s\omega_s} \quad (1)$$

$$T_2 = \frac{P_2}{\omega_m} = \frac{P_2}{\omega_s(1-s)} = \frac{3I_{2r}^2 R_r}{(2-s)\omega_s} \quad (2)$$

The developed torque is:

$$T = T_1 + T_2 = \frac{3R_r}{\omega_s} \left(\frac{I_{1r}^2}{s} + \frac{I_{2r}^2}{(2-s)} \right) \quad (3)$$

The positive and negative sequence currents are functions of their sequence voltages, machine parameters and the

slip s . An oscillating torque is introduced at twice the supply frequency as a result of the negative sequence currents. The power can also be expressed in terms of positive and negative sequence components as:

$$P_{in} = \text{Real} [3*(V_1 I_1^* + V_2 I_2^*)] \quad (4)$$

Fig. 8 gives a good indication of torque pulsations introduced as a result of network voltage unbalance.

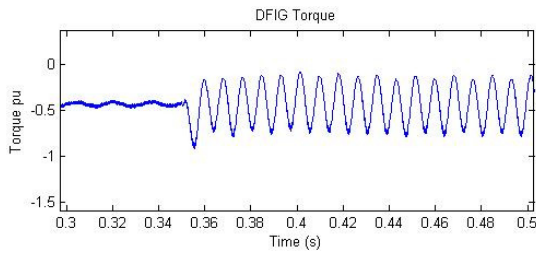

Figure 8 Torque Pulsations on DFIG Due to Network Voltage Unbalance

EFFECTS OF VOLTAGE UNBALANCE ON A DFIG CONVERTER

This section of the study deals with the effects that network voltage unbalance has on the rotor converter. Voltage unbalance can cause voltage harmonics on the dc bus of a DFIG, and lead to current harmonics. Positive and negative sequence components can be used to analyse the effects of voltage unbalance on converters. The cross product of positive and negative sequence components of voltage and current generate a $(2-\omega)$ frequency power ripple (where ω is the rotational speed) causing dc link voltage and current ripple [5,7,Error! Reference source not found.,Error! Reference source not found.]. Increased current harmonics on the dc link can shorten the life of the capacitor, or lead to capacitor failure. The bus ripple voltage can also lead to the generation of pulsating torques at the second line harmonic, similar to the effects on the induction generator shown in the previous section.

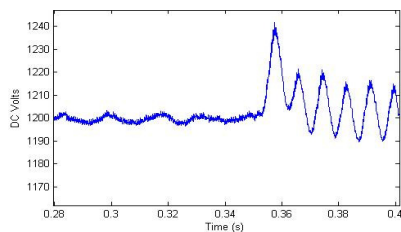

Figure 9 DFIG DC link Voltage Pulsations with Network Voltage Unbalance of 9%

Fig.9 shows the results of a simulation in Matlab/Simulink of the dc link voltage pulsations in the converter of a DFIG due to the effect of 9% unbalanced terminal voltage.

The Matlab/Simulink used in this paper is controlled in the d-q reference frame, with the d-axis aligned with the stator voltage vector [8]. Under the influence of voltage unbalance the stator I_d and I_q components will oscillate at twice the network frequency [7] shown in Fig 10.

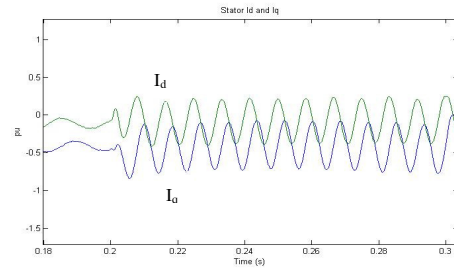

Figure 10

By using a band-pass filter to isolate \tilde{i}_d and \tilde{i}_q (where \tilde{i}_d and \tilde{i}_q are the double frequency terms produced by the network voltage unbalance), the current unbalance factor can be obtained,

$$CUF = \sqrt{\tilde{i}_d^2 + \tilde{i}_q^2} \quad (5)$$

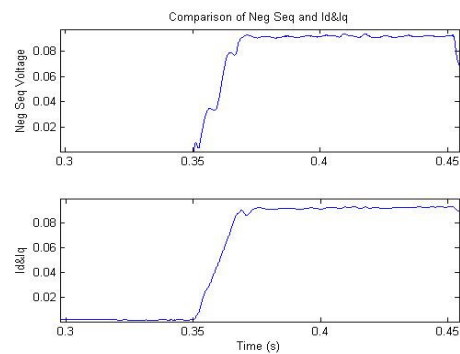

Figure 11

A comparison of VUF's obtained using stator symmetrical components and equation (5) is shown in Fig.11. It can be observed that that both methods produce a voltage unbalance in the region of 9%.

ALLEVIATION OF THE EFFECTS OF NETWORK VOLTAGE UNBALANCE

The issues associated with the connection of wind turbines and DFIG's to network grids with voltage unbalance, have been investigated [6,7]. In a DFIG the grid-side converter, dc link capacitor and transformer may function as a STATCOM. [6] uses this approach to design a control system to alleviate the problems on the DFIG as a result of unbalance voltage in the supply grid. [7] presents a novel controller design for a DFIG that provides adjustable speed and reactive power control and also reducing torque pulsations due to supply voltage unbalance. This design is based on using the stator and rotor I_d and I_q current

components to compensate for the torque pulsations. The torque equation of a DFIG is given by [7]

$$T_{em} = p/2 L_m (i_{sq} i_{rd} - i_{sd} i_{rq}) \quad (6)$$

Where L_m is the magnetising inductance, i_{sd} is the stator direct component, i_{sq} is the stator quadrature component, i_{rd} the rotor direct component and i_{rq} is the rotor quadrature component. From the appropriate induction machine q and d equivalent circuits the magnetising current is defined as

$$i_{msd} = i_{sd} + i_{rd} \quad (7)$$

$$i_{msq} = i_{sq} + i_{rq} \quad (8)$$

The torque equation can now be expressed as

$$T_{em} = p/2 L_m (i_{msq} i_{rd} - i_{msd} i_{rq}) \quad (9)$$

When the dq frame is synchronously rotating, the stator voltages are balanced, and the generator is in steady-state, all dq quantities are dc. The torque equation is then

$$T_{em} = p/2 L_m (I_{msq} I_{rd} - I_{msd} I_{rq}) \quad (10)$$

With I_{msq} , I_{rd} and I_{msd} , I_{rq} constant the torque will also be constant. However when voltage unbalance occurs in the supply network, this will cause perturbations in i_{msq} and i_{msd} at twice the synchronous frequency. The torque equation for unbalanced network voltage is [7],

$$T_{em} = p/2 L_m [(I_{msq} + \tilde{i}_{msq})(I_{rd} + I_{rdcomp}) - (I_{msd} + \tilde{i}_{msd})(I_{rq} + I_{rqcomp})] \quad (11)$$

I_{rdcomp} and I_{rqcomp} are compensating currents which can be added to the rotor converter control currents to cancel the effects of the oscillating i_{msd} and i_{msq} . The compensating currents can be determined by equating the terms of the balanced equation (10) with the unbalanced equation (11).

$$I_{msq} I_{rd} = (I_{msq} + \tilde{i}_{msq})(I_{rd} + I_{rdcomp}) \quad (12)$$

$$I_{msd} I_{rq} = (I_{msd} + \tilde{i}_{msd})(I_{rq} + I_{rqcomp}) \quad (13)$$

$$\begin{aligned} I_{rdcomp} &= -\tilde{i}_{msq} I_{rd} / (I_{msq} + \tilde{i}_{msq}) \\ &= -\tilde{i}_{msq} I_{rd} / i_{msq} \end{aligned} \quad (14)$$

$$\begin{aligned} I_{rqcomp} &= -\tilde{i}_{msd} I_{rq} / (I_{msd} + \tilde{i}_{msd}) \\ &= -\tilde{i}_{msd} I_{rq} / i_{msd} \end{aligned} \quad (15)$$

To alleviate the effects of voltage unbalance on DFIG's the current controllers for active power P and reactive power Q require compensation terms. The current compensation terms were incorporated in the DFIG Matlab/Simulink model in the rotor-side current control loop Fig. 12.

A single-phase load is introduced as shown in Fig. 1, and the model simulated in Matlab/Simulink for a simulated

time of 0.5 seconds. The simulation takes about 0.3 seconds to reach steady state. The single-phase load is therefore switched-in at 0.35 seconds and the A phase drops in magnitude from 1.0 pu to 0.88 pu Fig.13.

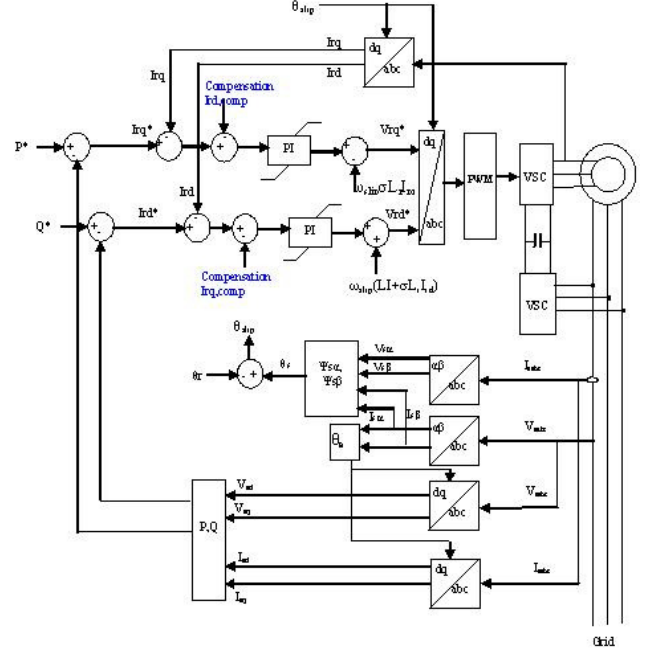

Figure 12 Current Control

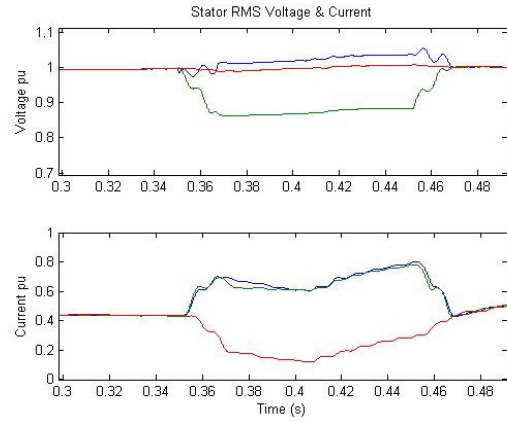

Figure 13 RMS Stator Voltage & Current

This represents a drop in the A phase voltage from a nominal value of 332 V to 288 V and results in the network voltage applied to the DFIG becoming unbalanced. A timer (set at 0.4 seconds) is used in the simulation model to delay the switching-in of the control compensation terms, Fig. 12.

Fig. 14 shows the amplitude of the dc link bus voltage at a steady value of 1200 V at 0.34 seconds. When the unbalance load is switched in at 0.35 seconds it introduces a negative sequence voltage of 9% which creates double frequency oscillations on the dc link bus. Control loop compensation is introduced at 0.4 seconds and the dc link

voltage oscillations decrease. The reduction in the rotor power oscillations at the grid-side converter can be seen in Fig. 15.

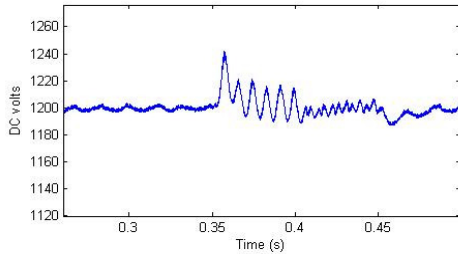

Figure 14 DC Link Voltage

The compensation terms become active at 0.4 seconds and there is a reduction in dc link voltage oscillations and rotor power oscillations, however Fig. 13 shows that there is an increase in stator current.

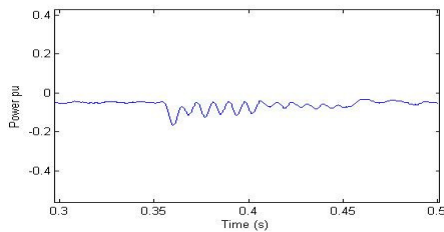

Figure 15 Rotor Power Grid-side Converter

The voltage profile on the rotor (grid-side converter) is similar to the stator, Fig. 16 with the A phase dropping to 0.88 pu.

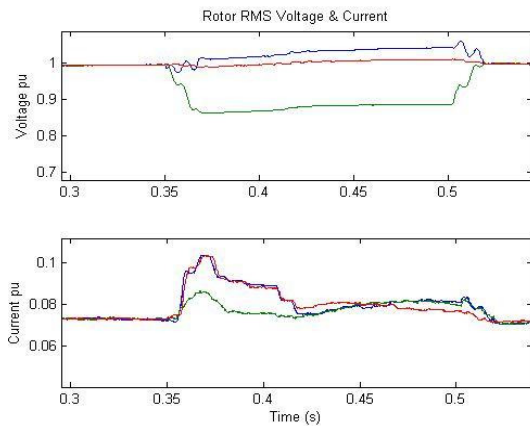

Figure 16 RMS Rotor Voltage & Current Grid-side Converter

When the unbalanced voltage is applied at 0.35s the current in all phases increase sharply. Before compensation is applied the rotor current in the two phases that did not have a voltage drop, is higher, but the A phase current is close to the situation during balanced voltage operation, Fig.16. When control compensation is applied the three phase rotor currents come closer to their original values.

CONCLUSION

The effects of voltage unbalance on a DFIG were investigated. Simulations showed that voltage unbalance when applied to a DFIG results in large current oscillation in both the induction generator and converter. A model of a DFIG in Matlab/Simulink was adapted and modified to incorporate a compensating control structure to alleviate the detrimental effects that network voltage unbalance has on DFIG's. The simulation results showed the improvement in the behaviour of the DFIG to network voltage unbalance when compensation was introduced.

REFERENCES

1. M. F. Conlon, M. Basu, N. G. Jayanti, and K. Gaughan, "A Survey of the Installed Wind Generation Capacity in Ireland", 2nd International Conference of Renewable Energy in Maritime Island Climates, 26-28 April 2006, Dublin, Ireland, pp. 55-60
2. A Larson, "The Power Quality of Wind Turbines," Dept. of Electrical Power Engineering, Chalmers University of Technology, Gothenburg, Sweden 2000.
3. Matlab. The Mathworks Inc.
4. M.F. Conlon and J. Kearney, "Negative Sequence Analysis of Induction Machines" 40th Universities Power Engineering Conference (UPEC), Cork, Ireland, 6th - 9th September 2005
5. S. D. Rubira and M. D. McCullagh, "Control of Double Fed Generators connected to the Grid by Asymmetric Transmission Lines", 33rd Annual IEEE Industry Applications Conference, 12th-15th Oct.1998
6. B. I. Naess, T. M. Undeland, T. Gjengedal "Methods for Reduction of Voltage Unbalance in Weak Grids Connected to Wind Plants", IEEE Workshop on Wind Power, Oslo 17.-18. June 2002
7. Ted Brekken, Ned Mohan, "A Novel Doubly-fed Induction Wind Generator Control Scheme for Reactive Power Control and Torque Pulsation Compensation Under Unbalanced Grid Voltage Conditions", in 34th Annual Power Electronics Specialist Conference, 2003. PESC '03. 2003 IEEE Vol. 2, 15-19 June 2003, pp. 760 – 764
8. K. Lee, Eaton Electrical, Giri Venkataramanan and Thomas M. M. Jahans, "Modelling Effects of Voltage Unbalances in Industrial Distribution Systems with Adjustable Speed Drives". Industry Applications Conference, 2004, 39th IAS Annual Meeting, Conference Record of the 2004 IEEE, Volume 4, 3-7 Oct. 2004 pp. 2579 – 2586.