



2000-09-15

The Design and Performance of an Evaporative Cooling Test Rig for a Maritime Climate

Ben Costelloe

Dublin Institute of Technology, ben.costelloe@dit.ie

Donal Finn

University College Dublin, donal.finn@ucd.ie

Follow this and additional works at: <http://arrow.dit.ie/engschmecon>

 Part of the [Architecture Commons](#), [Business Commons](#), [Education Commons](#), and the [Engineering Commons](#)

Recommended Citation

Costelloe, B. & Finn, D. (2000) The design and performance of an evaporative cooling test rig for a maritime climate. Proceedings of joint CIBSE/ASHRAE conference, Dublin September 2000. pp. 830-845.doi:10.21427/D7MC8M

This Conference Paper is brought to you for free and open access by the School of Mechanical and Design Engineering at ARROW@DIT. It has been accepted for inclusion in Conference Papers by an authorized administrator of ARROW@DIT. For more information, please contact yvonne.desmond@dit.ie, arrow.admin@dit.ie, brian.widdis@dit.ie.



This work is licensed under a [Creative Commons Attribution-NonCommercial-Share Alike 3.0 License](#)



The Design and Performance of an Evaporative Cooling Test Rig For a Maritime Climate.

**Ben Costelloe, MSc., C.Eng., MCIBSE., MinstE.
Lecturer, Faculty of Engineering, Dublin Institute of Technology.**

**Donal Finn, PhD., C.Eng., M.ASHRAE.
Lecturer, Department of Mechanical Engineering, University College Dublin.**

Abstract

Recent developments have prompted a review of the use of cooling tower based evaporative cooling technology as an effective means of cooling modern buildings. Prominent among these developments is the success of high temperature cooling systems such as radiant ceiling panels and chilled beams. At present, however, there is little published literature which gives a quantitative, in depth analysis of the performance or energy efficiency of cooling towers, used in maritime climates, in conjunction with heat exchangers and run at low approach and low wet bulb temperatures throughout the free cooling season. This lack of knowledge has meant that many current opportunities to benefit from the technology are not availed of by building design teams. To address this issue an automated laboratory test rig has been specifically developed with the aim of optimising the performance and demonstrating the potential of this form of cooling in maritime conditions. This paper, which reports on work in progress, describes the design and development of the rig and presents and analyses the preliminary test results.

1.0 Introduction

Traditionally, the cooling requirements of buildings have been met by convection cooling employing chilled water systems. In commercial buildings such cooling has largely been generated by vapour compression refrigeration systems producing chilled water at 5 to 8⁰ C. The dominance of convection cooling systems has been reduced in recent years by the success of radiant cooling in the form of chilled ceiling panels and beams (1). Chilled ceiling panels and beams typically require a supply of cooled water at 15⁰C with a return temperature of 18⁰C. Elevated chilled water temperatures raise the possibility of generating the required cooling in cooling towers. Hence the view has developed that cooling tower based evaporative cooling systems ought now to be the subject of a major review, as a practical and low energy means of cooling modern buildings (2,3). Three parallel developments have reinforced this view. As a

result of better fabric insulation, lower glazing levels and more successful use of solar shading the cooling load in the modern deep plan office building is now dominated by the internally generated sensible load. The cooling season in such buildings is not confined to the Summer months, but extends into periods of the year with good evaporative cooling availability due to the lower ambient wet bulb temperatures experienced. There has also been, in recent years, a trend towards increasing sophistication in the design of towers and fluid coolers. The recent introduction of the hybrid closed cooling tower, which integrates dry, adiabatic and evaporative cooling in one unit, is a case in point. Inverter driven variable speed fans are also increasingly used in cooling towers as a means of optimising energy consumption in chilled water plant (4). Since Legionnaires' disease was first recognised in 1976, there has been widespread concern about the health risks associated with cooling towers. It is now accepted, however, that the prevention of Legionnaires' disease in cooling towers is a matter of quality assured maintenance and operating procedures (5). An important feature of cooling towers which are used exclusively in free cooling applications is that the extent of the risk of growth of legionella in such towers is far below that of towers used in cooling refrigeration condensers. This is due to the fact that the water temperature in such towers is generally below 20⁰C.

In the course of the current research programme, the following aspects have been identified as requiring detailed research and analysis:

1. The optimisation of tower design for free cooling applications in maritime climates.
2. The optimisation of tower based free cooling systems for energy consumption.
3. The energy efficient control of tower output, particularly during Winter operation.
4. The evaluation of cooling potential using meteorological data for various locations.
5. Environmental and safety issues, such as water consumption and water quality.

To address these issues an automated laboratory test rig has been developed as one element of a research programme devoted to this form of cooling. The objectives of the research are to demonstrate the potential and optimise the performance of this form of cooling in modern buildings, located in maritime climates. The current paper describes the design of the test rig and analyses the initial test results.

2.0 Background

The standard approach to indirect water side free cooling is to treat the system in the context of a large water cooled, normally centrifugal, chilling plant, which is designed to serve conventional air conditioning loads at standard temperatures, typically 7°C. The system is usually designed as a changeover system, which, by routing the cooling tower water and the cooling load water through a plate heat exchanger, bypasses the condenser and evaporator circuits, and thereby provides cooling without operating the refrigeration compressor. Opportunities for free cooling are typically seen to arise, when the sensible cooling load reduction and the diminished requirement for dehumidification, occurs, in the off-peak months in conjunction with lower ambient wet bulb temperatures. The extent of the annual energy savings which can be achieved vary with each project, but are typically of the order of 30% with a payback period of under 3years. This is the general approach of most recently published work in this field including De Saulles (3) and Murphy (6).

In the literature two main strategies are advocated for maximising cooling availability – raising the chilled water temperature as the seasonal cooling load falls and the use of additional cooling tower capacity as a means of reducing the cooling tower approach temperature (the temperature difference between the cool water exiting from the tower and the ambient air wet bulb temperature). Additional tower capacity can be provided either by multiple towers or alternatively by the selection of the tower on the basis of the free cooling duty with an approach of, typically, 3°C, as opposed to selection on the basis of the Summer duty with an approach of 6 to 10°C. Generally, for indirect free cooling systems, a combined approach of 5°C is advised, composed of a 3°C approach at the tower with a 2°C approach across the heat exchanger. De Saulles (3), presents a BSRIA modelling analysis by extrapolating from the performance of a typical cooling tower which has been sized for normal Summer cooling duty. This analysis states that a tower selected on the basis of a 2°C approach temperature will have an “oversizing margin” of 400 to 500% above a tower selected on the basis of Summer conditions. Murphy (6), also advocates selecting on the basis of the free cooling duty with an approach of 3°C and presents data for one tower producing water at 13°C at an ambient wet bulb of 9.5°C. However the general lack any published test data and in-depth analysis, or optimisation, for cooling towers at low approach, low range, and low wet bulb temperatures is not addressed other than to state that data can be obtained from manufacturers on a “project specific basis”.

At present there is little detailed reference, or analysis, in the literature, on the application of free cooling technology to water based high temperature sensible cooling systems in general and to chilled ceiling panels and chilled beams in particular. Such systems offer major free cooling potential due to the high cooling water temperature used and the fact that they are designed as sensible only cooling systems. With such systems, as Table 1 shows, the free cooling availability of chilled water at 15°C can be as high as 80%. Hence, if a combined approach temperature of 3°C is achieved the system will operate in the free cooling mode for the major portion of the year, where ambient conditions are suitable. This requires a change in the standard design approach. With high temperature cooling systems it is more appropriate to design the heat rejection system to optimise free cooling than to dissipate condenser heat. An essential question arises in the case of the recently developed induction chilled beam, which can operate at chilled water temperatures as high as 18°C, as to whether the cooling tower system could be designed to provide year round cooling. In the case of the chilled ceiling panel a similar question arises on the impact on the room conditions of allowing the system to operate on a free cooling basis throughout the year. This would require a very low combined approach temperature of 2 to 3°C but would remove the changeover requirement, simplify system operation and allow the tower to be optimised for a single function.

If a 3°C combined approach is achieved, the analysis presented in Table 1, suggests that conventional chilled water temperatures of 7°C can be produced by cooling towers, on average, for 22% of the year in Dublin, Ireland. On the same basis, temperatures of 15°C can be produced for 81% and temperatures of 18°C for 96% of the year. On this basis, therefore, chilled ceiling panels and beams could be supplied, in Irish climatic conditions, for approximately 7,000 hours per annum. In the London area, on the basis of the Heathrow data (1949-1976) presented by De Saulles (3), it would be possible to generate 15°C cooled water for approximately 6,300 hours per annum or 72% of the average year.

Table 1
Frequency of Occurrence of Hourly Wet Bulb Temperature
in Dublin in the Period 1966 –1995

External Wet Bulb Temperature Degree C	Number of Occurrences at the Wet Bulb Temperature	Number of Occurrences at & Below the Wet Bulb Temperature	Percentage of Occurrences at & Below the Wet Bulb Temperature	Chilled Water Temperature Possible at 3 Degrees C Combined Approach	Average Annual Hours at & Below the Wet Bulb Temperature
-9	0	0	0.00	-6	0
-8	9	9	0.00	-5	0
-7	25	34	0.01	-4	1
-6	55	89	0.03	-3	3
-5	98	187	0.07	-2	6
-4	196	383	0.15	-1	13
-3	490	873	0.33	0	29
-2	1152	2025	0.77	1	68
-1	2406	4431	1.68	2	148
0	5348	9779	3.72	3	326
1	7899	17678	6.72	4	589
2	10631	28309	10.77	5	944
3	13342	41651	15.84	6	1388
4	15025	56676	21.55	7	1889
5	18012	74688	28.40	8	2490
6	19672	94360	35.88	9	3145
7	20705	115065	43.76	10	3836
8	20285	135350	51.47	11	4512
9	20372	155722	59.22	12	5191
10	20229	175951	66.91	13	5865
11	19773	195724	74.43	14	6524
12	18383	214107	81.42	15	7137
13	16412	230519	87.66	16	7684
14	13435	243954	92.77	17	8132
15	9260	253214	96.29	18	8440
16	5355	258569	98.33	19	8619
17	2712	261281	99.36	20	8709
18	1196	262477	99.81	21	8749
19	367	262844	99.95	22	8761
20	92	262936	99.99	23	8765
21	29	262965	100.00	24	8766
22	3	262968	100.00	25	8766
23	0	262968	100.00	26	8766
Total	262,968				

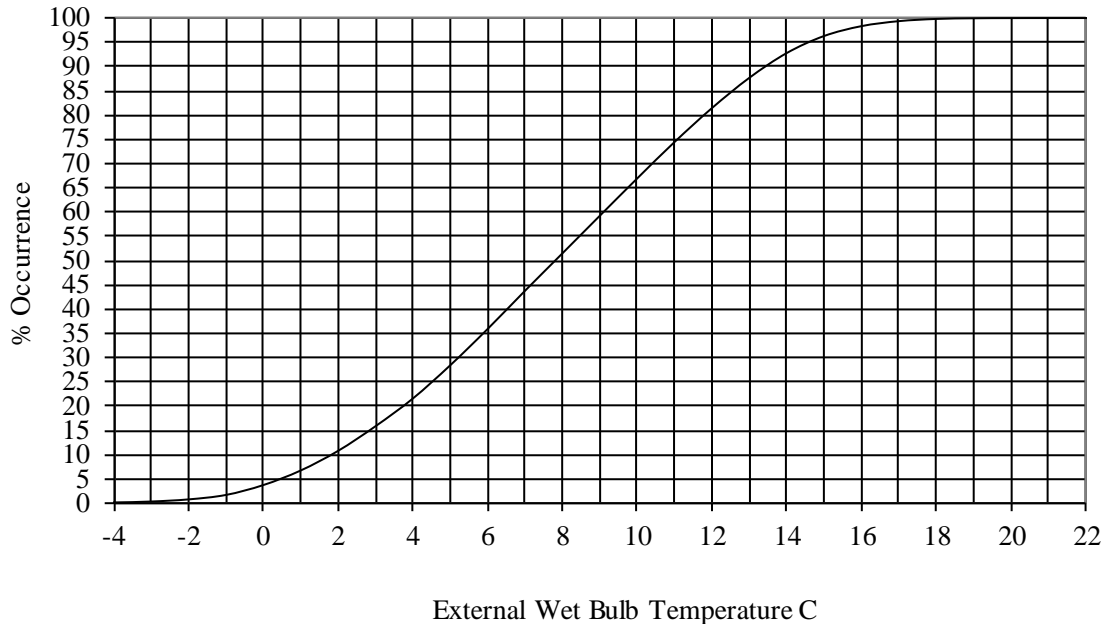

Figure 1 Wet bulb temperature occurrence in Dublin in the period 1966-1995

Watt (7), has comprehensively documented the use of evaporative cooling technology including tower based free cooling systems in inland areas of the USA with a high ambient wet bulb depression. While there has been some limited use of the technology in Northern Europe in recent times the number of applications is low and very far short of its potential. Some significant measures have been taken, recently, to improve general technical awareness of the various permutations which the technology can offer, notably by De Saulles (3), however, many current opportunities to benefit from free cooling are still not availed of by building design teams. This situation has been attributed by Field (8), to the lack of adequate technical guidance documentation on the subject. There is, therefore, a need to build greater confidence in the system by a further deepening of our technical knowledge of the system performance through research and analysis.

Cooling towers, which are used in indirect free cooling applications, have two unique features which both maximise cooling availability and electrical energy consumption. The design approach temperature is low, ideally about 2⁰C, and the design range temperature (the difference between the flow and return temperatures at the tower) is also low - typically 1 to 3⁰C. As the temperature difference on the secondary side cooling circuit is also low - typically 2 to 3⁰C for

chilled ceiling panels or beams, the circuit mass flow rates (and hence the pump powers) per unit of load are thought to be higher than with conventional chilled water and condenser water circuits. Hence the necessity to optimise the balance between system electrical energy consumption and cooling generation.

3.0 The Requirement for Experimental Facilities

While wet bulb temperature availability can readily be determined from meteorological records the translation of such availability into cooling potential requires a comprehensive knowledge of tower performance, in maritime locations, specifically under conditions in which a low approach, low range and low wet bulb temperature are required. Such data are not currently available. In general, published tower performance data is confined to approach temperatures above 3⁰C, range temperatures above 5⁰C and wet bulb temperatures above 15⁰C (9). In tower based free cooling systems which have been designed to maximise free cooling availability the design range will lie between 1 and 4⁰C with an approach temperature of 1 to 4⁰C and with design wet bulb temperature between 6 and 18⁰C.

Figure 2 shows the test rig in schematic form. An open, external, forced draught, counter flow tower linked to an internal plate heat exchanger offered many operational and performance advantages in this research. The tower is located at roof level 20 m above local ground level in a city centre location and approximately 4 km from the sea coast. The other elements of the test rig are contained in the laboratories located at ground level. In order to facilitate measurement across a range of conditions it was necessary to provide a means of heat input to the tower which could be controlled in response to varying levels of heat rejection. It was considered that this load was best provided by an in-line electric heater with thyristor control as the method which offered greatest flexibility, greatest control range and which could readily be provided in a laboratory environment. A 24 kW electric heater capacity was selected on the basis that this capacity is large enough to give accurate correlated performance data, while not being excessive in terms of load and running costs.

The Design and Performance of an Evaporative Cooling Test Rig For a Maritime Climate.

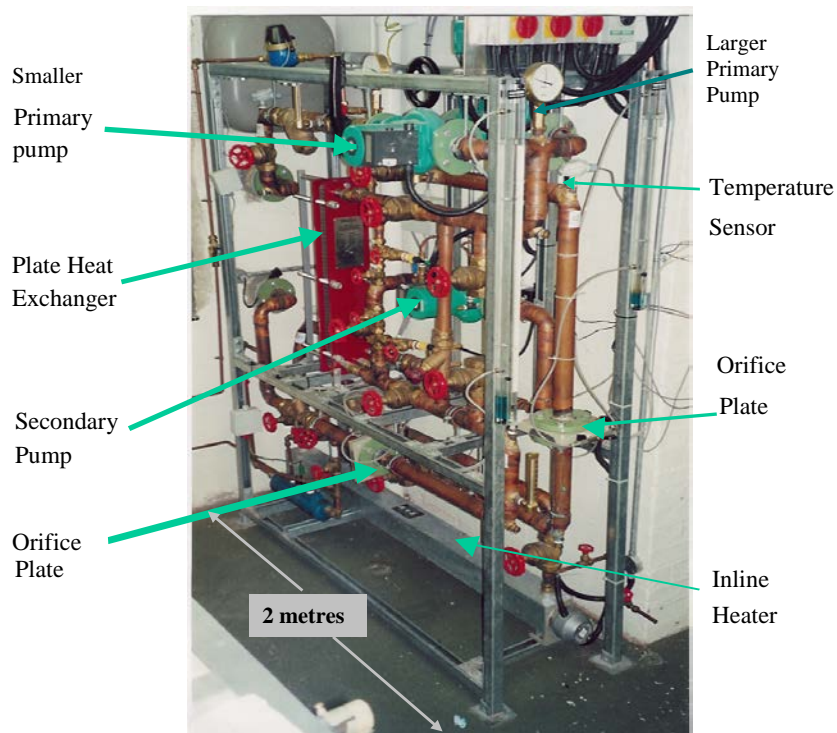
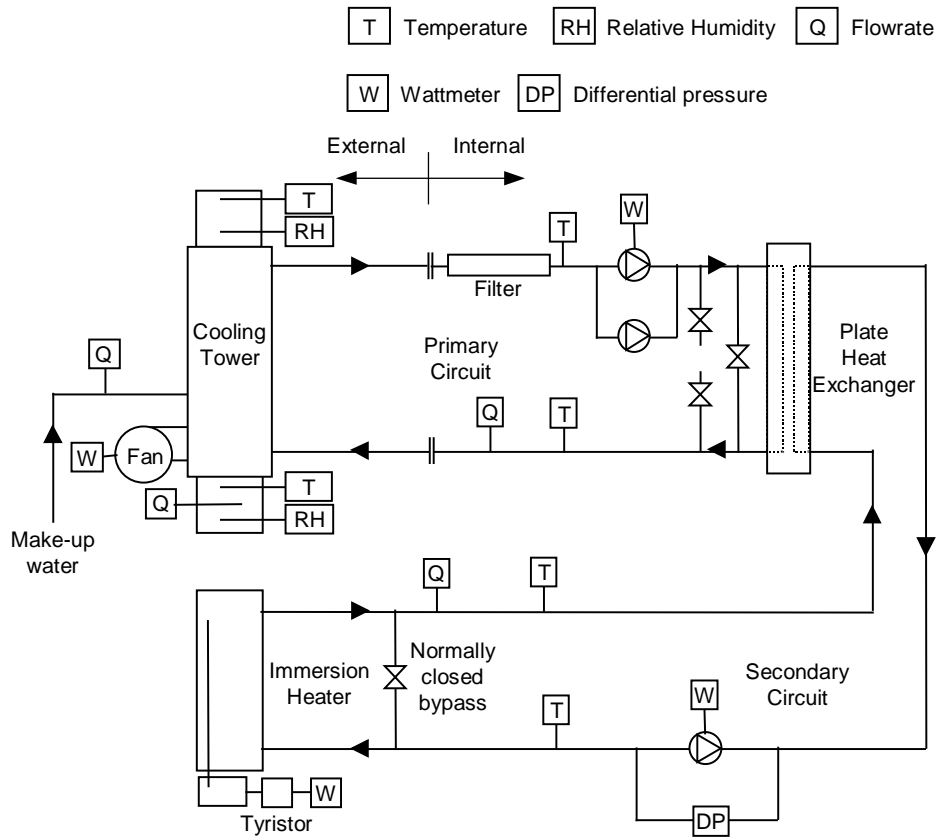

Figure 2 Schematic Diagram and Photograph of Evaporative Cooling Test Facility

3.1 The Design of the Cooling Tower

The selection of an appropriate tower configuration was one of the aspects that had to be considered at an early stage in the design process. The following issues were considered:

1. The configuration of the tower, whether forced, induced or cross draught.
2. The heat exchange arrangement, whether open tower or closed circuit tower or open with an external heat exchanger.
3. The control of the tower air flow rate.
4. The extent and arrangement of the fill sections.

A fundamental decision which has to be made in all tower based free cooling systems is the arrangement which is to be used to separate the primary tower water from the secondary system water. Traditionally, two methods have been used to achieve this separation; the open cooling tower linked to an external heat exchanger and the closed circuit cooling tower. A third possibility - the strainer cycle arrangement does not aim to separate both systems but rather to clean the tower water sufficiently to enable it to be used directly in the cooling system, (10). With contemporary applications for this technology such as chilled ceiling panels and chilled beams it is highly desirable to physically (and thereby also chemically) separate the two water circuits. This action will also allow different static pressures to be employed in each circuit. The strainer cycle arrangement offers none of these advantages. Modern plate heat exchangers used with towers are capable of operating with temperature differences between primary and secondary flow of as low as 1.1°C (6). Hence the availability deficit between open and heat exchange systems can be minimised, albeit at the expense of the pump power required to ensure a turbulent heat transfer in the exchanger. Under Irish climatic conditions, for example, on the basis of Table 1, availability decreases from 88 to 81% per annum if 14°C water from a tower is used to generate 15°C secondary water rather than using 15°C tower water directly, based on a tower primary approach of 2°C .

However, there are significant performance and operational disadvantages also in incorporating the heat exchange element within the tower, as with the closed circuit tower arrangement. The coil normally used in the closed circuit tower is a plain tube bundle, without fins or other heat transfer enhancements. Possibilities for rearranging and enhancing heat transfer surfaces in the course of the research programme would therefore be more limited in closed towers than in conventional open towers with modern packings. As part of the secondary circuit is outdoors, other problems would arise with freeze protection of the secondary water during Winter operation. For these reasons it was decided to use an open tower with an indoor plate heat exchanger.

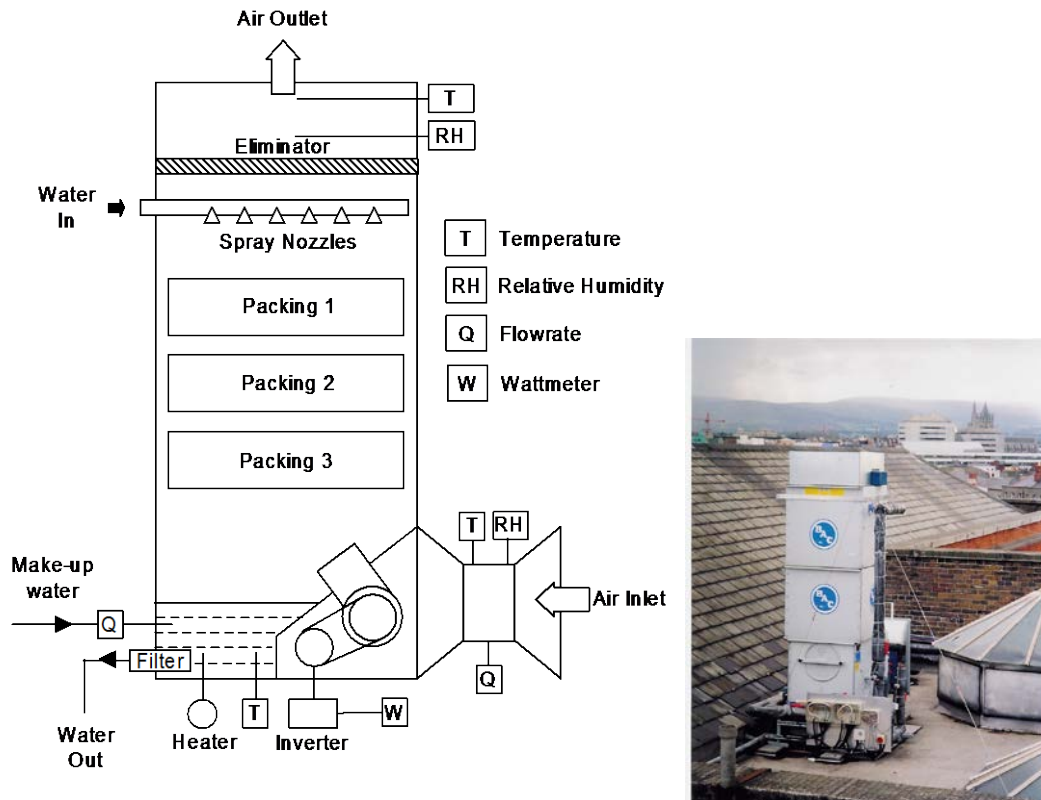

Figure 3 Experimental Cooling Tower Configuration

As shown in Figure 3, the tower used in the test rig has been designed to accommodate a range of operating conditions. Three fill sections have been incorporated. Hence it is possible to run the tower with one, two or three fill heights. Inverter based fan control is exploited to facilitate flexible testing. The fill material, which is a matt plastic matrix arranged in a diamond pattern in horizontal section and in a wave-form in vertical section, was chosen to allow better heat transfer by maximising air and water contact within the packing.

As the tower air volume flow rate is variable, it was considered necessary to incorporate a means of continuous measurement of this flow rate. This is achieved by static and total pressure grids located in a purpose designed air intake section. In these circumstances a single air inlet tower with instrumentation in the dry ambient conditions at entry offered certain research advantages over multiple inlet towers such as the induced draught and cross draught arrangements. A belt driven centrifugal fan also offered greater operating flexibility and pressure development. On this basis, therefore, it was concluded that an open forced draught counter-flow tower offered best research potential. Watt (7), has also documented the low approach

temperatures achieved with tall counter-flow cooling towers in areas with a high ambient wet bulb depression, in the southern states of the USA.

3.2 The Design of the Primary and Secondary Circuits

The design condition of the secondary circuit was selected as 15⁰C flow and 18⁰C return as being typical of chilled ceiling panel systems. The flow rate is 1.5 L/s. The design conditions for the primary circuit follow from those set for the secondary circuit. The design condition of the primary water flow (14⁰C) was chosen on the basis that a minimum of 1⁰C temperature difference is required between primary and secondary flow temperatures in order to maximise cooling availability. The primary return temperature of 15.8⁰C and primary flow rate of 2.5 L/s follow from the requirements of the heat exchanger. The main difficulties encountered in selecting suitable pumps for the rig were the necessity to cater for a range of flow rates and pressures and the high pressure drop through the heat exchanger at the upper limit of the flow rate range in the primary circuit. The secondary circuit duties are catered for with a single three speed pump. In order to cater for the range of duties in the primary circuit two pumps were used.

A decision was taken early in the design of the rig to use a fully automated control and monitoring system. This was considered necessary, particularly for the purpose of automatically gathering data on the cooling performance of the rig with daily and seasonal variations in the external ambient conditions. To simulate the variable cooling load of an actual installation the power input to the electric heater on the secondary circuit is controlled via a thyristor. Hence the secondary return water temperature can be controlled or varied by this means. The control options built into the software can be used to simulate various operating and load demand situations, which are encountered in real installations. The electrical energy consumption of the tower fan, all pumps and the electric heater is measured and logged. This enables the energy consumption efficiency of various operating conditions to be computed.

3.3 Water Analysis and Treatment System

It is generally necessary to treat the primary water content of cooling towers to control the level of scale deposits on the heat exchange surfaces, to limit corrosion and to prevent the propagation of harmful organisms. In view of the widespread health and safety concerns now associated with the use of cooling towers, particularly in commercial buildings, it was considered necessary to have a fully automatic monitoring and dosing system incorporated into the test rig. This measure will enable water quality and water consumption to be constantly monitored and logged. The water treatment system consists of an electronic controller which receives inputs from a

temperature, conductivity and pH sensor, a water make-up meter and a bleed water meter. Outputs from the controller are provided to the scale and corrosion inhibitor pump, the biocide injection pump and the automatic water bleed valve. Dosing by the scale and corrosion inhibitor is proportional to the water make up rate, while the biocide injection pump is controlled on a timed event basis - to cater for dormant periods.

While water consumption levels are an important consideration, the main focus of concern in cooling towers lies in minimising the risk of Legionnaires' disease. However, the optimum temperature for the multiplication of legionella is 37°C. Below this temperature the multiplication rate decreases and can be considered insignificant below 20°C, (11,12). With a combined approach temperature of 3°C cooling tower pan water will exceed 20°C only when wet bulb temperatures exceed 17°C. Table 1 indicates that such wet bulb temperatures are exceeded, on average, only 57 hours per year. Hence the extent of the risk of growth of legionella in towers used in free cooling applications is far below that of towers used in rejecting heat from refrigeration condensers.

4.0 Preliminary Test Results

The preliminary test results are summarised in Table 2. The approach temperature of the primary and secondary circuit was measured at loads of 24, 19, 15 and 9 kW. A series of 13 tests were conducted at tower air intake wet bulb temperatures ranging from 6.4 to 11.1°C. As the objective of the initial test programme was to demonstrate the potential of this form of cooling, all operating parameters were set to maximum for each test. The cooling tower was run with all three packing sections in operation, with maximum air flow rate and with maximum primary and secondary water flow rates through the plate heat exchanger in order to minimise the cooling range at the tower and also the secondary approach temperature. Primary approach temperatures in the range 2.3 to 0.6°C were measured depending on load and tower air intake wet bulb temperature. Secondary (or combined) approach temperatures of 4.3 to 1.4°C were also measured.

Table 2
Summary of Preliminary Test Results

Load	Wet Bulb Temp.	Primary Flow Temp.	Secondary Flow Temp.	Primary Approach to WBT	Secondary Approach to WBT
KW	Degree C	Degree C	Degree C	Degree C	Degree C
24	6.4	8.7	10.7	2.3	4.3
24	8.9	10.8	12.5	1.9	3.6
24	9.2	11.1	12.8	1.9	3.6
24	11.1	12.8	14.6	1.7	3.5
19	8.4	9.8	11.3	1.4	2.9
19	9.2	10.6	12.1	1.4	2.9
19	10.2	11.3	12.9	1.1	2.7
15	8.7	9.7	10.9	1	2.2
15	9.3	10.6	11.7	1.3	2.4
15	9.7	11.1	12.3	1.4	2.6
15	10.6	11.6	12.8	1	2.2
9	9.2	9.8	10.6	0.6	1.4
9	9.1	9.7	10.5	0.6	1.4

5.0 Discussion of Results

Figure 4 shows a clear decline in primary and secondary approach temperatures with load reduction. As shown in Figure 5 a secondary approach temperature of 3°C is achieved at a load of 20 kW. The introduction of the plate heat exchanger results in a secondary approach temperature which is approximately twice the primary approach in all cases. This can be clearly seen in Figure 5 and in the magnitude of the constants shown in the two exponential equations. The secondary and primary approach temperatures are indicated by equations

$$T_{SAT} = 0.867e^{0.062W} \quad \text{and} \quad T_{PAT} = 0.3511e^{0.0719W}$$

Where T_{SAT} and T_{PAT} are the primary and secondary approach temperatures and W is the cooling load imposed in kW.

The temperature difference between secondary and primary flow temperature varied with load from 2.0 to 0.8°C. The temperature difference of 1.1°C between primary and secondary flow temperature stated by Murphy (6), was confirmed for the heat exchanger design load of 12kW. The approach temperatures seem to display a limited dependence on air intake wet bulb temperature for the 24 and 19 kW loads. However additional tests are required across a wider range of wet bulb temperatures in order to further develop this aspect.

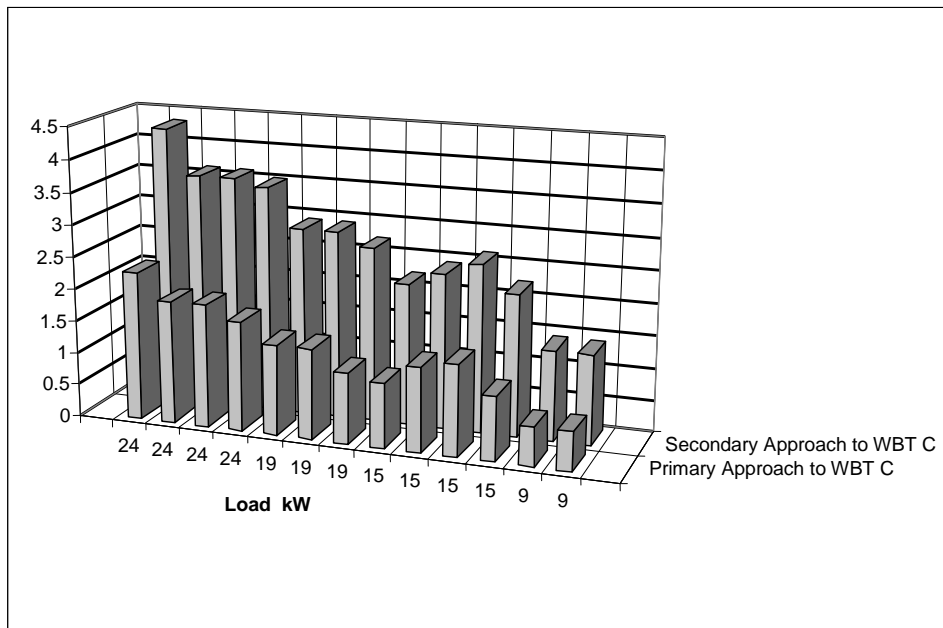

Figure 4 Primary and Secondary Approach to Wet Bulb Temperature Determined

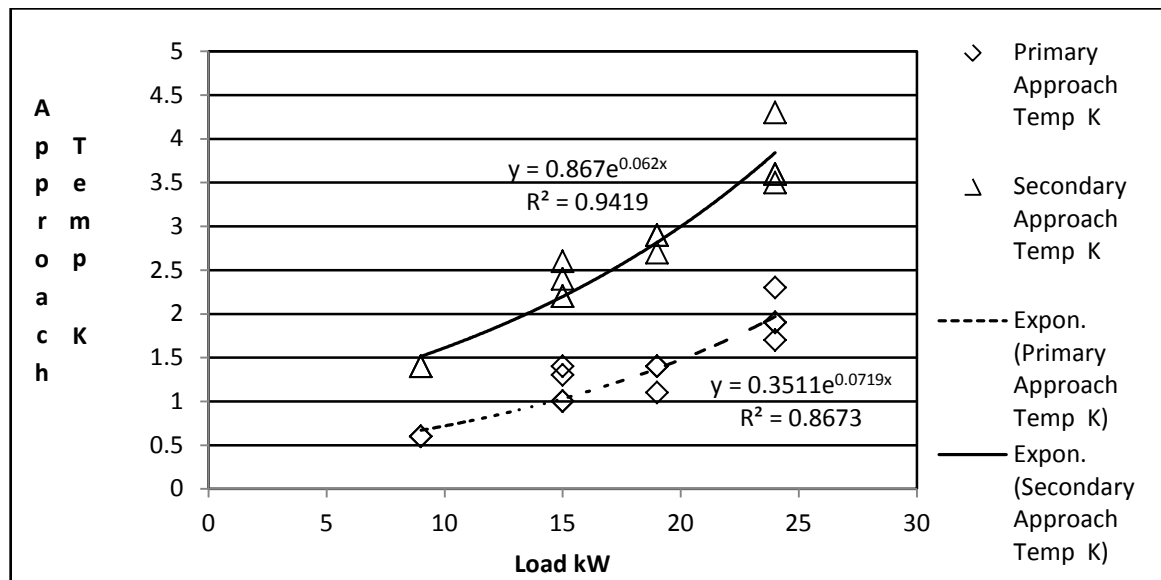

Figure 5 Exponential Variation in Primary and Secondary Approach Temperatures with Load

6.0 Conclusions

The initial test results confirm the potential of this form of cooling in maritime climates. A secondary approach temperatures of 3°C was achieved with a cooling load of 20 kW, with a tower air mass flow rate flux of 3.5 kg/sm² and with a tower water mass flow rate flux of 2.8 kg/sm². The tower cross sectional area was 0.92m², which implies a heat rejection rate of 1kW per 0.046 m² of tower cross sectional area. For a cooling load of 20kW the introduction of the plate heat exchanger raised the approach temperature by 1.5°C. In the case of chilled ceiling panels which require a supply of water at 15°C this reduces availability in accordance with Table 1 from 90% to 81%. In the case of chilled beams operating at a supply temperature of 16°C the availability is reduced from 94 to 87%. In neither case is the reduction in availability sufficient to support a strong case against the use of the indirect system. Indeed the recently developed induction chilled beam which can operate with a chilled water supply temperature of up to 18°C implies a 96% availability with the indirect system, based on these results. In general, therefore, it is possible to design an indirect heat rejection system, based on close approach principles and utilising modern plate heat exchangers in conjunction with enhanced evaporative cooling techniques, which is capable of generating secondary cooling water at a temperature of 3°C above the ambient wet bulb temperature. Such cooling water can be used to effectively cool modern buildings, in maritime climates, by means of contemporary high temperature cooling systems such as chilled ceiling panels and chilled beams. The extent of the availability of cooling water, generated in this manner, is so wide that it comes very close to providing year round cooling for such systems. This aspect needs further research but it holds out the prospect of eliminating the refrigeration plant for water side sensible cooling, removing the changeover requirement, simplifying system operation and offering major reductions in energy consumption.

Future research programmes will be devoted to the further optimisation of evaporative cooling design, to the energy efficient control of cooling tower output and to an in-depth cooling availability analysis.

7.0 Acknowledgements

This research programme has been supported by a research grant from the CIBSE (Republic of Ireland Branch) research fund, by an applied research grant from Enterprise Ireland, and by the DIT, Faculty of Engineering, research seed fund. Equipment and services have also been donated by many private companies and individuals. The support of the Buildings Office, DIT and of the laboratory technician staff of Department of Engineering Technology is also acknowledged.

8.0 References

- (1) Tassou, S. (edited), Low energy cooling technologies for buildings. London: I.Mech.E. Seminar publication, 1998.
- (2) De Saulles, T. Free cooling revisited. Building Services Journal. Vol. No. (12), pp 39-40, 1995.
- (3) De Saulles, T. Free cooling systems. Bracknell (UK): BSRIA, 1996.
- (4) Calder, K. Optimising the control of chillers. Building Services Journal. Vol. No.5 (May), pp28-29, 1995.
- (5) Brundrett, GW. Legionella and Building Services. Oxford: Butterworth-Heinemann, 1992
- (6) Murphy, D. Cooling towers for free cooling. ASHRAE Journal. Vol. No.6 (June), pp. 16-26, 1991.
- (7) Watt, J.R. Evaporative air conditioning handbook. New York: Chapman and Hall, 1986.
- (8) Field, J. Building analysis - 1 City Square Leeds. Building Services Journal, Vol. No.12 (Dec), pp14-18, 1998.
- (9) Hensley, J.C. (edited) Cooling tower fundamentals. Kansas: The Marley Cooling Tower Company, 1985.
- (10) Smith-Haddon, W.F. Free cooling systems using the plate heat exchanger and strainer cycle methods. Proceedings of joint CIBSE/ASHRAE conference. Dublin, 1986
- (11) CIBSE. TM13, Minimising the risk of Legionnaires' disease. London: CIBSE, 1987
- (12) HS(G)70. The control of legionellosis including Legionnaires' disease. Health and Safety Executive, UK, 1993.