



2008-05-01

# Robots Assist in Treatment of Stroke Patients

Philip Deering

*Technological University Dublin*

David Kennedy

*Dublin Institute of Technology, david.kennedy@dit.ie*

James Conlon

*Dublin Institute of Technology, James.Conlon@dit.ie*

Follow this and additional works at: <https://arrow.dit.ie/engschmecart>



Part of the [Mechanical Engineering Commons](#)

## Recommended Citation

Kennedy, D., Conlon, J.: Robots assist in treatment of stroke patients. *Engineers Journal*, Vol.62, issue 4, May, 2008.

This Article is brought to you for free and open access by the School of Mechanical and Design Engineering at ARROW@TU Dublin. It has been accepted for inclusion in Articles by an authorized administrator of ARROW@TU Dublin. For more information, please contact [yvonne.desmond@dit.ie](mailto:yvonne.desmond@dit.ie), [arrow.admin@dit.ie](mailto:arrow.admin@dit.ie), [brian.widdis@dit.ie](mailto:brian.widdis@dit.ie).



This work is licensed under a [Creative Commons Attribution-NonCommercial-Share Alike 3.0 License](#)



# ROBOTS ASSIST IN TREATMENT OF STROKE PATIENTS

Robotic rehabilitation is a field of biomedical engineering which combines precise mechanical design with control technology through the interaction of medical and engineering professionals to produce a new tool in medical rehabilitation.

Philip Deering, David Kennedy, CEng FIEI, and Jim Conlon, CEng MIEI of the Department of Mechanical Engineering, Dublin Institute of Technology Bolton Street Dublin provide an overview of the development of an interactive robot for the medical rehabilitation of stroke victims.

Paralysis is one of the common symptoms of a stroke sufferer; a medical condition causing weakness in one side of the body. It is treatable with a course of physiotherapy and interactive robotics can greatly accelerate recovery. Although robotic rehabilitation is a relatively new technology its benefits are well recognised.

The objective of this research work was to develop an interactive robot for the medical rehabilitation of stroke victims. This interactive robot will reduce labour intensive procedures, accelerate rehabilitation and provide a valuable aid for rehabilitation therapists. At present, a typical rehabilitation session for a patient suffering from paralysis requires a therapist to execute exercises involving hand on hand interaction. The therapist takes the patient's hand and guides him/her through a series of exercises. Such exercises require circular or diagonal movement, arm extension, retraction and hand movement. **Figure 1** shows a typical exercise path movement for the arm. For instance, green diagonal lines show the elbow motion and yellow, the shoulder motion. The blue circle and square show how both elbow and shoulder regions can be combined in some exercises. The interactive robot design developed allows the patient to carry out such exercises without the assistance of a therapist. Different exercise paths and degrees of difficulty can be selected from a menu and exercises can be carried out at any time in any suitable location, and/or at home.

## Vast range of conditions

The range of medical conditions encountered by stroke sufferers is vast and it can have an impact on every aspect of the body from speech to the control of movements. 75 to 85% of stroke sufferers are over the age of 65. However, in the UK

and Ireland, 10,000 people under the age of 55 suffer a stroke each year. Paralysis is a major symptom of a stroke where weakness is caused in one side of the body due to a lack of blood flow to the brain.

As a result, brain cells die due to a lack of oxygen and nutrients. A major concept in the understanding of paralysis is muscle memory. Examples of this occur in golf techniques and cycling, for instance, and strokes can affect this. Hand-eye coordination can also be affected. The loss of the muscle memory needs to be re-established in order to recreate the communication process affected by a stroke.

In a typical session for a stroke victim suffering from paralysis, a therapist will execute simple exercises that involve hand on hand interactions. The patient is guided through exercises such as making circles, extending or retracting the arm or moving the hand in a diagonal motion.

As a patient may only receive a few hours per week with a physiotherapist, this device can execute simple exercises with patients independently and thus the rehabilitation rate of the patient may be increased. For this work, an interactive robot was developed as a therapy aid for rehabilitation of the upper limbs. The design is based on a two-dimensional, planar coordinate system and the robot is capable of executing exercises based on profiles. Robot rehabilitation was developed in the late 1980s by a mechanical engineer, Prof. Neville Hogan (DIT and MIT) and clinical trials conducted in 1994 proved the positive benefits of this process.

## Types of strokes

The blockage of a blood vessel in the brain or neck is the most common form of a stroke and is called an ischemic stroke. Ischemic strokes account for 80% of strokes suffered. These

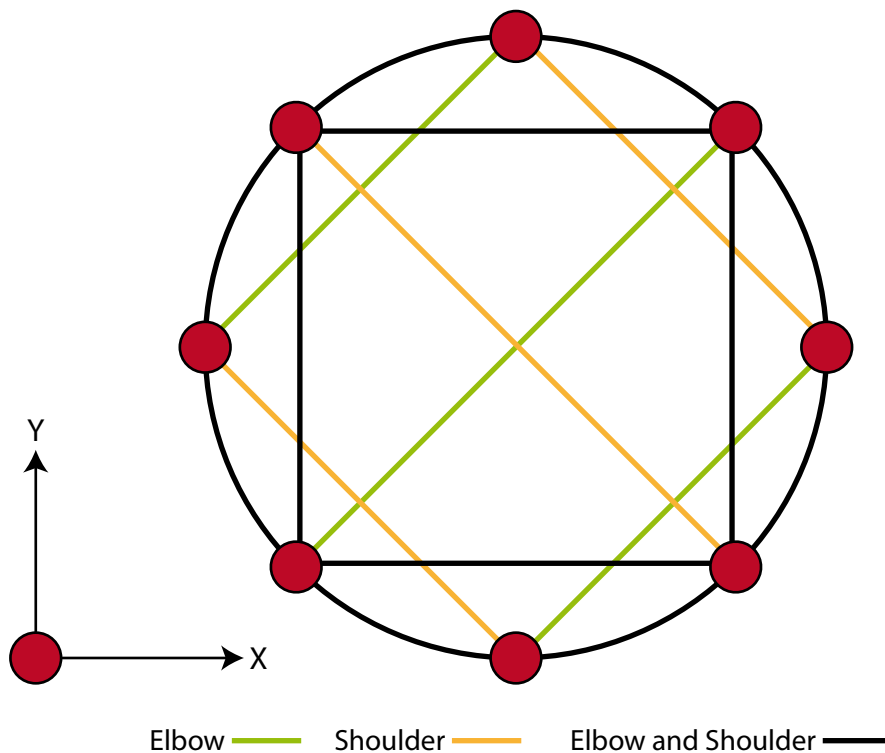

Figure 1. Examples of exercise paths.

blockages can arise from three conditions;  
 formation of a blood clot within a blood vessel in the neck or brain – thrombosis  
 movement of a clot from another part of the body to the neck or brain - embolism  
 severe narrowing of an artery leading to the brain – stenosis  
 Hemorrhagic stroke accounts for about 20% of strokes suffered. They result from the weakening of a blood vessel which in turn ruptures and bleeds into the surrounding brain. The blood accumulates and compresses the surrounding brain tissue. An aneurism is the ballooning of a weakened blood vessel which if left untreated can rupture and bleed into the brain. A stroke can have many different affects due to the complexity of the brain. The most common symptoms of a stroke include the following;  
 paralysis or weakness of one side of the body  
 dysarthria – muscles of speech impaired causing slurring  
 dysphasia – muscles of swallowing impaired  
 Visual defects – double vision, decreased visual acuity  
 sensory impairment – absent or diminished response to touch, pain, pressure  
 intellectual impairment – memory loss, poor judgement or reasoning

#### How the robot works

Essentially a patient holds a handle that is capable of moving freely through a planar envelope. This action is combined with that of the robot to apply a force to the handle when guidance is required. A patient sits viewing a PC screen that shows the desired exercise path and the position of an end effector (handle) grasped and held by the hand. The patient must use hand-eye coordination to move it along the desired path. The robot guides the hand along the desired path which can be a desired shape and has the option to be interactive.

In this case, deviation from the desired path increases the resistance to movement (impedance).

As outlined in **Figure 2**, the end effector is free to move in the direction of the desired path as seen by the rollers. The motion to the left and right of the desired path is restricted by the spring-damper arrangement, offering the patient guidance. The spring and damper forces (and thus the impedance) are programmable, providing gradable exercises. This will be necessary as the patient's condition improves and his/her dependence on the robot for guidance reduces. Impedance control is in essence a PD controller. The response of an impedance controller is based on both the magnitude of the error and the rate of change of error. As applied to this work, the response is dependent on the displacement from the desired path and the speed of the end effector (rate of change of position). The path options can take many shapes or approaches, each one working different regions of the arm.

#### Machine construction

To achieve planar motion, linear guides were utilised combined with timing belts driven by DC servo motors. The control aspect was given by two position control units controlled via a visual basic program. Three main areas of interaction between the robot and patient were developed. These consisted of a demonstration exercise where the patient is lead through the exercise, a guidance exercise where the patient attempts a specific exercise but is offered guidance from the robot if an error is made and thirdly, a gradable exercise where a patient attempts to follow a profile, the attempts are recorded against time to analyse the rehabilitation progress. The mechanical design is based on an

X-Y table format which consists of linear guides for smooth motion and a toothed belt drive system for precision motion. The DC brushless servo motors that drive the X-Y table are capable of producing enough force to resist and, if necessary, to overcome the external force produced by the patient's hand. Experimentation showed that a maximum force of 100 newtons (N) was a sufficient force to exert in all directions. The brushless motors offer little resistance to motion. Brushless DC motors are used in direct drive applications due to their high torques and low wear, slow creep capabilities, instant stall torque and good power to weight ratios. For this work the motors were required to constantly work at very low speeds almost constantly at standstill relative to their possible maximum speed, but still produce sufficient stall torque.

The motors are capable of exerting and resisting a wide range of stall torques when required to do so by the controller. As the motors are constantly at standstill, thermal considerations were taken into account. Most motors have a cooling affect due to their speed of rotation.

It was verified that the motors would not exceed their thermal limits while still providing the required characteristics.

Critical to the development of the rehabilitation robot was the need for positional accuracy and smooth motion. This was taken into account in the selection of the guide system and drive mechanism. The mechanical system was required to offer low frictional resistance, smoothness and accuracy.

There are many possible linear guide systems available for this. However the linear guide system selected was the Hepco

track and wheel system. The guide rail mechanism offers good accuracy and smoothness and is capable of withstanding the high loads and moments which may be applied.

#### Motor selection

The motors used were Maxon EC 90 flat brushless motors. They are 90 watt, digitally controlled motors which output a maximum continuous torque of 0.5 Nm and a stall torque of 4.5Nm. As the motors are digitally controlled they incorporate three hall sensors for digital commutation. The thermal capabilities allow the motors only to take a current of 2.12Amps continuously although the motors are capable of taking 20Amps starting current.

The dimensions of the motors are 90mm in diameter and 30mm in thickness. The coupling is a 10mm shaft, 30mm in length. The hall sensors give a position accuracy of 72 counts per revolution. Initially this seems inadequate but, as seen in **Figure 3** with the 1:3 ratio the accuracy is increased to 216 counts per revolution on the shaft which applies the linear motion. The final accuracy in terms of linear motion is 0.45mm.

#### EPOS – position control units

The Maxon motor, Epos 24/5 is a small-sized, full digital smart motion controller. The Epos is directly compatible with the Maxon EC flat motor range for use with digital hall sensors and encoders.

The sinusoidal current commutation by space vector control offers to drive brushless EC motors with minimal torque ripple and low noise. The integrated position velocity and

**Omega Financial Management**

## Take Control of Your Own Pension

Did you know you can?

- Decide what shares you want in your pension?
- Buy property and borrow up to 75% of the cost?
  - Invest in gold and other commodities?
  - Place your money on a high rate deposit?

**Tax Relief**

You can do all this and get tax relief on your contributions

**What about my existing pension fund?**

That's no problem, your existing fund can be transferred to your new fund and consolidated with your new contributions.

You can mortgage up to 75% of the purchase price and use your pension fund for the remaining 25%. Standard Life will provide the solicitor and the management company for you.

"I used Omega to organise my pension last year and I found them very helpful and professional. I prefer to have a more hands on approach to where my funds are invested. Having the choice is more appealing to me." A.Boyle, Dublin

Call Omega Financial at 1850 260 261  
110 - 112 Rock Road, Booterstown, Co. Dublin  
www.omegafinancial.ie john@omegafinancial.ie

**STANDARD LIFE**

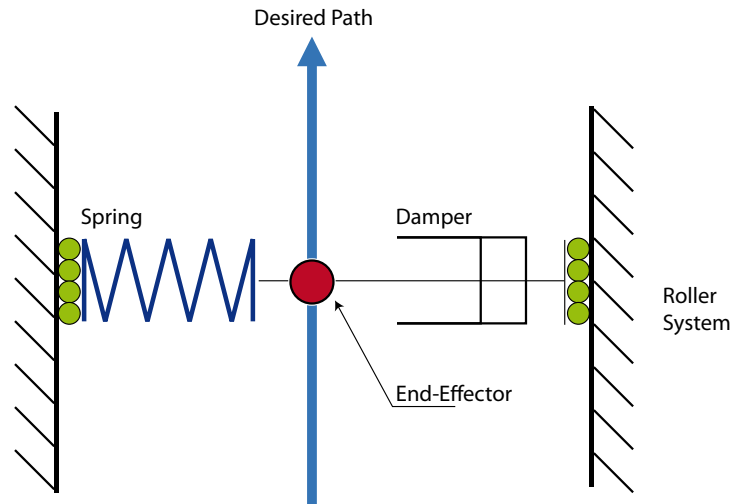

Figure 2. Control system.

current control functionally allows sophisticated positioning applications. It is specially designed for slave and master functions in networking applications and because of this, multi-axis systems are easily implemented.

The unit can be operated through an RS232 communication port. Epos offers a Windows-based graphical user interface for set-up, start-up and auto-tuning. Some of the other main features of the Epos 24/5 are;

- digital position reference by pulse direction or master encoder velocity and acceleration feed forward
- sinusoidal or trapezoid path generator
- software error handling
- status reporting
- no additional heat sink necessary
- single supply voltage
- general purpose digital I/O's and analogue inputs
- diagnostic wizard

Maxon also offers programming examples for MS Visual C++, MS Visual Basic and National Instruments Lab View.

### Control strategy

The control strategy is based on two position control units. Each direction of motion has a dedicated closed-loop control system. The controllers are interlinked through a can field bus system and connected to a standard PC using an RS232 connection. The control loops drive the end effector around the desired path and a visual basic programme continuously changes the position controller's set point to execute the desired path/profile. The rate at which Visual Basic changes the set point determines the speed of the exercise.

To implement the guidance factor of the robot, a PI current controller is used. The position of the end effector is read by the Visual Basic programme. This value, combined with its position relative to the desired path, is used to set the required guidance force. The required forces are set in terms of current set values for both the X and Y axes, utilising the closed loop current controllers.

To implement both control modes, the controller's gain settings were analysed using software supplied by Maxon. Implementation of the interactive screen involved using a second graphics port on the PC, connected to a second visual display unit on the robot. Back driveability is the ability of a mechanical system to be driven back against its own force such as in a motor and gearbox combination.

### Hall sensors

A hall sensor is a transducer that varies its output voltage in response to changes in magnetic field density. Hall sensors are used for proximity switching, positioning, speed detection and current sensing applications. Frequently, a hall sensor is combined with circuitry that allows the device to act in a digital (on/off) mode, and may be called a switch in this configuration. Hall sensors are commonly used to time the speed of wheels and shafts, such as for the timing of an internal combustion engine or tachometers. A single

# abacus

## Transportation Surveys

Ireland's first video & manual transportation data collection agency

Video Traffic Surveys  
Manual Traffic Surveys  
Roadside Interviews  
Registration Plate Surveys  
Pedestrian Surveys  
Queue Length Surveys  
Public Transport Surveys  
Radar Speed Surveys  
Journey Time Surveys  
Parking Surveys  
Rolling Camera Surveys  
Street Inventories  
Professional Photography

39a Connaught St., Athlone,  
Co. Westmeath  
Tel: 00064 98740  
Fax: 00064 98741

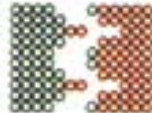

[www.abacus-surveys.ie](http://www.abacus-surveys.ie)

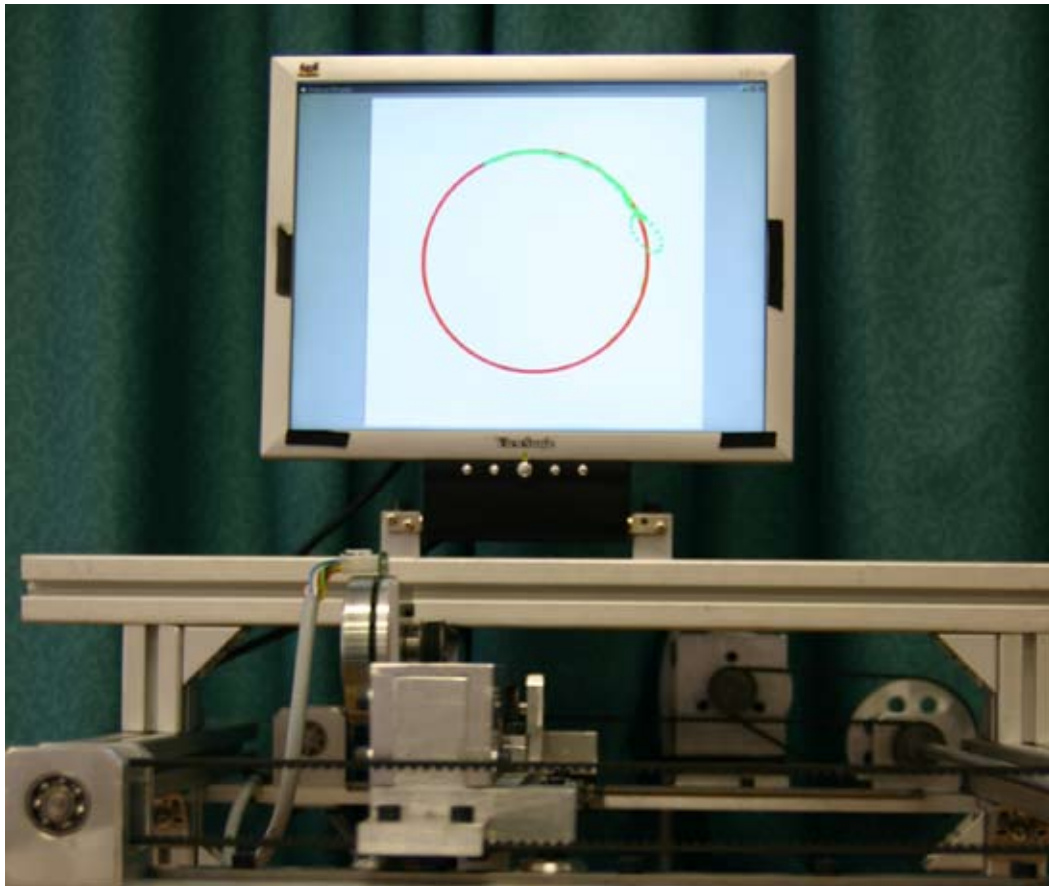

The complete robot rig.

hall sensor may be used for speed control of a motor but if the number of sensors is increased position control may be utilised. The possibility of this depends upon the accuracy required. Also when two hall sensors are installed in a motor offset by angle  $\alpha$ , the direction of rotation can also be determined.

**Power amplifiers**

Power amplifiers are used in applications where the power required to drive a load is greater than power limits of the control elements such as data acquisition cards and potentiometers. For example a motor rated to 60 volts used with a data acquisition card that may have a range of 0 – 5 volts. A power amplifier must be used to amplify the signal from the data acquisition card. This is illustrated in **Figure 4**.

It is possible to have a measurement system where the sensor and signal processing such as amplification and analogue to digital conversion are carried out with separate components. These are often available in a single integrated circuit. These systems are known as smart systems. One industrial example of a smart system is the EPOS, a position control unit available from Maxon Motors for use with their EC brushless motor range. This particular unit inputs both digital and analogue signals and can output up to 4 digital signals. The unit's main features are;

- point to point positioning – position is in relation to the axis zero point or current axis position.
- position control with anticipatory control – the combination of controlling feedback control and controlling feed forward measures provide ideal control.

- speed control – the motor axis retains speed until a new speed is set.
  - torque control – a constant torque can be controlled
  - electronic gear head – the motor can follow a reference input produced by an external source or encoder.
  - capture inputs – the current position value can be saved when a positive or negative flank of an input appears.
- A detailed 3D model of the robot was compiled in solid edge. This model served two main purposes; as the model had many moving parts, it could be easily checked for possible

Figure 3. Linear accuracy.

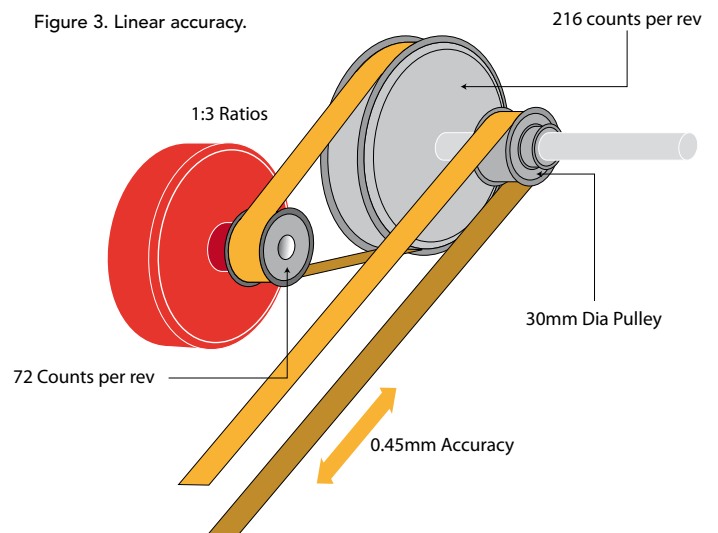

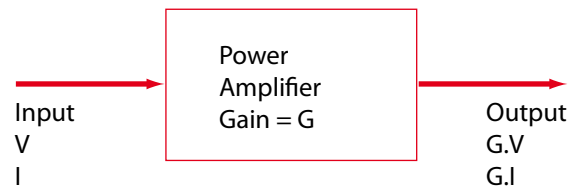

Figure 4: Power amplifier block diagram

collisions and tolerances; as it was compiled in solid edge, a detailed set of working drawings could be extracted for the manufacturing process.

#### Visual Basic

The Microsoft Corporation released Visual Basic (VB) in 1987. It was the first visual development tool from Microsoft. Currently release 6.0 is on the market and is established as one of the leading programming packages for engineering. In recent years, great progress has been made in the interaction of Visual Basic (VB) and control engineering. It allows users to create simple graphical user interfaces but also a flexibility to develop complex applications. Programming in VB is a combination of visually arranging components or controls on a form, specifying attributes and writing additional lines of code for more functionality. VB

is common to most professions, therefore it can be easily integrated into a medical environment.

#### Instructing the robot

When all the parameters have been set, the user is prompted to enable the robot and send the end effector to the start position. This is done by instructing the robot, through the command button, to move to the start position and establishing if it had reached the start position using a timer. There were two possible ways to send the robot to the start position, via position mode or by using profile position mode. The profile position mode was selected due to the fact that it offered no overshoot and that the speed at which the end effector moved could be controlled.

This is denoted by the number 1-profile position mode. Once the operation mode is set, the parameters controlling the



**Be the best you can be at Ireland's education capital.**

## Graduate Opportunities in Food Engineering and Engineering Technology

### Masters Degree in Food Engineering (MEngSc)

This programme provides a comprehensive grounding in bioprocess and food manufacturing systems engineering. The programme will be of particular interest to graduates in Engineering, Science and related disciplines who are interested in food and bioprocess engineering, risk assessment, product and process development, process control and advanced food manufacturing systems.

### Masters Degree in Engineering Technology (MSc)

This programme addresses the need for enhanced technical skills in the Irish agrifood and bioresource industries. It will be of interest to graduates in Science or related disciplines and provide them with state-of-the art technical skills in sustainable energy, mechanisation technology, food supply technology and environmental technology.

To apply online for these one-year full-time courses, visit [www.ucd.ie/apply](http://www.ucd.ie/apply)

For further information contact: Dr Enda Cummins, UCD School of Agriculture, Food Science & Veterinary Medicine on 01 716 7476 or [Enda.Cummins@ucd.ie](mailto:Enda.Cummins@ucd.ie)

Courses commence in September 2008

*These graduate programmes are part of UCD's commitment to innovative 4th level education and are coordinated through the UCD College of Life Sciences Graduate School.*

[www.ucd.ie/agfoodvet](http://www.ucd.ie/agfoodvet)

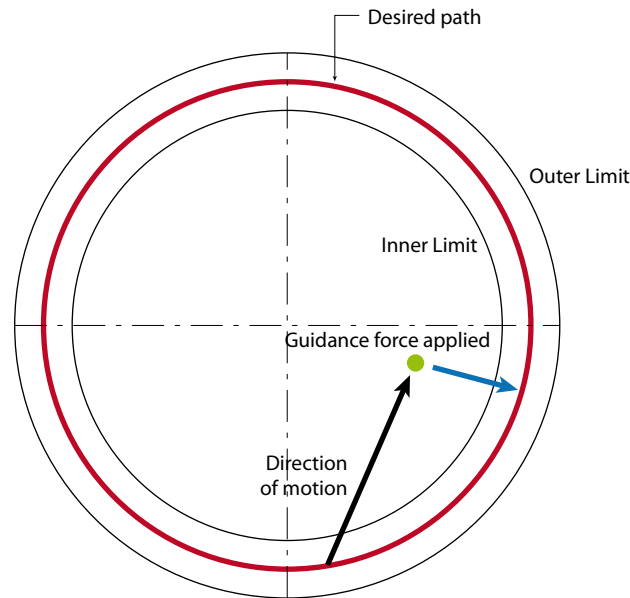

Figure 5. Direction of guidance force applied.

motion must be set. This is done for both EPOS units in the software code developed. The profile speed is set to 400rev/s and the profile acceleration and deceleration are set to 500rev/s<sup>2</sup>. Next the Epos units are instructed to move to the start position.

Note the start position is the 0 degree coordinate on the circumference of the circular path.

In terms of the 600mm by 600mm working envelope and Cartesian coordinates the positions are 300+R in the X-direction and 300 in the Y-direction where R represents the radius. In the code, the desired X and Y positions are set. Two “true” values indicate that the motion is absolute and to start immediately. Finally, the timer controlling the start position sub-procedure is enabled to establish when the start position has been reached.

### Analysis of finished exercises

The first exercises, which lead the patient through a specific circular profile, execute efficiently with the speed and size of the circular profile being easily adjustable. The smoothness of this exercise may be increased with the addition of greater accuracy in position sensing and an increase of the execution time of the software to allow a greater number of set points around the circular profile.

The guided exercises have room for improvement before reaching the standard required for the medical profession. As the patient executes the circular profile, at present the response is purely dependent on position. It would be much more desirable to have the response dependent on the rate of change of position as well as position. This would implement a true impedance controller (or PD controller).

Another factor in the implementation of the guidance force is

the direction in which the force is applied. To implement the guidance force, the actual position of the end effector is used to locate the line. This line is perpendicular to a tangent of the circle. The force is then exerted, in a direction along this line, towards the desired path as seen in **Figure 5**.

It is noticeable that the force applied becomes almost perpendicular to the direction of motion. This is a somewhat unsatisfactory response from the controller.

A possible solution to this problem is to include direction of motion/direction of error signals in addition to those for position and speed.

If the gradable exercise is satisfactory, the patient experiences an apparently frictionless motion due to the bias current and his/her attempt can be accurately assessed against time. Enhancement of this exercise will come from fine tuning of the implementation of the bias currents.

Also, an increase in execution speed would allow a wider range of information to be recorded during the exercise, such as instantaneous speed and displacement and so give more accurate information of the patient’s attempts and recovery. The development of software to accurately interpret the data received from the exercise and compare it to previous exercises would also be beneficial. This would clearly illustrate the benefits of the device and point to further developments in this field of application for interactive robotics.

### Future enhancements

To enhance the design, the use of encoders to improve linear accuracy and the implementation of a CAN Bus system to improve speed is recommended. With these factors in place, more challenging aspects such as the implementation



of impedance control and the development of challenging exercises may be undertaken. The most critical aspect of further development is the implementation of impedance control. The major concept of interactive robotics is the ability to offer guidance to the patient with impedance control being critical to efficient implementation. Along with the addition of encoders and a CAN Bus, force sensors, rather than current sensors as an indication of force could be incorporated into the design. The force sensors would improve direction, motion control, accuracy and strength capabilities.

**Final Comments**

This work has provided a foundation for further research in the field of interactive robotics with the next major step being interaction with the medical environment, to achieve both accreditation and advice on how to progress with development within the field. Currently all design considerations have been taken from an engineering perspective on medical procedures. Within the development of exercises, issues of the control of the

direction of the guidance force to be applied and the method of implementing the force need to be considered. For example, if the patient makes a mistake, should the force, which restricts mistakes and guides the patient back to the desired path, be removed once the patient begins to correct their mistake? Furthermore, should guidance start from the desired path or once the bandwidth has been exceeded? Work on medical interaction would form the starting point for further development and provide a great insight into other aspects of the project.  $\Phi$

**Philip Deering is a 2007 graduate of Mechanical Engineering at DIT and is now employed by Siemens Ireland Ltd.**

**Jim Conlon and Dr. David Kennedy are members of Mechanical Engineering at DIT. The paper presented here is based on the final year Mechanical Engineering Project work of Philip Deering at DIT.**

**ITT**

**The clock is ticking**

Save energy and money with Lowara

The HYDROVAR<sup>®</sup> variable speed controller is great news for the planet as well as your pocket.

- Reduces the energy consumption of pumps by up to 70%
- Can be retrofitted to most types of pump
- Saves money and reduces carbon dioxide emissions

Every minute counts, so contact Lowara today.

*Engineered for life*

**Lowara**

Lowara Ireland Ltd.  
 Millwood Hill, Tullybrannigan, Galway, Republic of Ireland, Dublin 24  
 Tel: +353 (0) 91 200 200 Fax: +353 (0) 91 200 111  
 Email: [Lowara@ITT.com](mailto:Lowara@ITT.com) Web site: [www.lowara.ir](http://www.lowara.ir)