



2017

Investigation into the Local Nature of Change of Frequency in Electrical Power Systems

Damien Doheny

Dublin Institute of Technology, damien.doheny@mydit.ie

Follow this and additional works at: <http://arrow.dit.ie/sjer>



Part of the [Engineering Commons](#)

Recommended Citation

Doheny, Damien (2017) "Investigation into the Local Nature of Change of Frequency in Electrical Power Systems," *Student Journal of Energy Research*: Vol. 2: No. 1, Article 3.

doi:10.21427/D7X05G

Available at: <http://arrow.dit.ie/sjer/vol2/iss1/3>

This Article is brought to you for free and open access by the Journals Published Through Arrow at ARROW@DIT. It has been accepted for inclusion in Student Journal of Energy Research by an authorized administrator of ARROW@DIT. For more information, please contact yvonne.desmond@dit.ie, arrow.admin@dit.ie, brian.widdis@dit.ie.



Investigation into the Local Nature of Rate of Change of Frequency in Electrical Power Systems

Damien Doheny

Postgraduate researcher, Dublin Institute of Technology.

Corresponding Author: Damien Doheny, damien.doheny@mydit.ie

ABSTRACT: Over the coming years it is expected that considerably more wind power will be connected to the Irish power system. This will result in a power system that at times of high wind power penetration will operate with very low inertia, making the system susceptible to large rate of change of frequency (RoCoF) events due to disturbances. These high RoCoF events could result in the cascade tripping of generators connected to the grid resulting in complete shutdown of the system. This paper investigates the differences between local RoCoFs seen at individual buses and system wide RoCoFs seen across the entire power system. A model of the IEEE 39 bus power system was implemented and simulated with Power Systems Simulation for Engineers (PSS/E). Matlab was then used to process and analyse the results. The simulations and results show that after a disturbance on a power system, local RoCoFs close to the disturbance could occur that are significantly larger than the system RoCoF and predicted RoCoF.

KEY WORDS: RoCoF, RoCoRS, local frequency, local RoCoF, power system inertia.

1 Introduction

Ireland's binding energy commitment is to achieve a renewable energy share (RES) of 16% of final energy use by 2020. To achieve this, national sub targets have been set. These targets are 40% RES-electricity, 12% RES-Heat, 10% RES Transport and a 20% reduction in energy use through energy efficiency measures. To achieve the 40% RES-Electricity (RES-E) sub target, significant amounts of renewable energy are required to be connected to the national electricity grid. To date, wind energy has made the most significant contribution to the RES-E target. Since 2005 an average of 180 MW per year of wind energy has been connected to the grid, however, in order to meet the 2020 target this connection rate needs to increase to 250/300 MW per year (Scheer et al. 2016).

Traditionally, synchronous generators have been used to generate and supply electrical energy to the national grid, however, as the penetration of wind energy increases, synchronous generators become more and more displaced, resulting in a reduction in the total power system inertia. This makes frequency regulation more difficult and imposes a limit on maximum instantaneous wind energy penetration and can result in curtailment.

The frequency of an electrical power system is dependent on the rotational speed of the synchronous generators; hence, their speed must be kept constant to maintain rated frequency. A steady state speed and frequency is achieved when the mechanical power input to the electrical generators equals the electrical power demand plus losses on the electrical power system. To maintain this power balance elaborate control systems are used to regulate the mechanical power input to the electrical generators. Should a sudden disturbance occur on the electrical power system, such as a large generator or load becoming disconnected, the control systems will not react quickly enough and a momentary power imbalance will exist, causing the generator's speed and the power system frequency to deviate. Depending on the severity of the power imbalance, it could take tens of seconds to minutes for the control system to restore the power balance and return the system to rated frequency.

The magnitude of the power imbalance resulting from a disturbance determines how quickly the generator's speed and system frequency changes. This is termed the Rate of Change of Frequency (RoCoF), measured in Hertz per second [Hz/s], and is used as a measure of the severity of a disturbance. Disturbances that produce high RoCoF events can have detrimental effects on a power system. In

severe cases, generator protective devices may operate and disconnect the generator from the power system, synchronous generators may lose synchronism with the power system or anti-islanding RoCoF relays may operate, disconnecting distributed generation from the power system. These could initiate a cascade effect and further exacerbate the original disturbance, ultimately leading to complete shutdown of the power system. Hence, it is important that electrical power systems are designed and operated in such a way as to avoid or reduce the severity of high RoCoF events.

The objective of this paper is to investigate how disturbances, such as the loss of a generator, affects the local frequency and RoCoF in an electrical power system. This was done using a computer model of the IEEE 39 bus system that was simulated under various scenarios by applying different disturbances to the model. This paper is structured as follows. Section 2 reviews the literature on RoCoF and its relevance to the Irish power system, section 3 details the methods used to perform the simulations and analyse the results, section 4 presents and discusses the results and section 5 draws conclusions based on the results.

2 Literature Review

The inertia of the rotating mass of an electrical generator plays an important role during a disturbance; it acts as a short-term energy storage medium and releases or absorbs energy while a power imbalance exists, reducing the RoCoF. The inertia of the individual generators connected to a power system contribute to the total power system inertia. In relation to electrical power systems, inertia is given the symbol H and is measured in terms of its stored rotational energy in Mega Watt seconds [MW.s] or is sometimes referred to as the inertia constant and expressed in per unit form, with units of seconds [s]. Power systems should maintain a minimum level of inertia to avoid high RoCoF levels in the event of a disturbance.

(Anderson & Fouad 2003) defines a fictitious inertial centre of a power system as:

$$\frac{d\bar{\omega}_\Delta}{dt} = -\frac{P_\Delta}{2\sum_{i=1}^{N_g} H_i} \quad (1)$$

Where $\frac{d\bar{\omega}_\Delta}{dt}$ is the mean retardation of all machines in a power system after a disturbance, P_Δ is the change in power due to the disturbance, H_i is the inertia constant of machine i and N_g is the total number of machines in the power system. (Anderson & Fouad 2003) emphasis that the system as a whole will retard at a rate given by the inertial centre, however, the individual machines will retard at different rates governed each machine's individual swing equations, and only after a transient period will all the machines retard at the same rate. This inertial centre is often used to determine the RoCoF of a power system after a disturbance, however, it only considers the average rate of change of speed of all the machines, i.e. the system rate of change of speed. It is only accurate after an initial transient period and does not take account of the initial rate of change of speed of the individual machines immediately after a disturbance.

One of the adverse effects of increased wind power penetration is that traditional synchronous generators become displaced and the overall system inertia reduces. Fixed speed wind turbines do not decrease power system inertia, however, the rotating mass of variable speed wind turbines is decouple from the grid frequency, because of their power electronic converters, and do not inherently exhibit an inertial response unless controlled for that specific purpose (Muljadi et al. 2012). Although fixed speed wind turbines do contribute to power system inertia, most grid connected wind turbines are variable speed with double fed induction generators (DFIG) due to their superior energy capture and improved control capabilities (Ruttledge & Flynn 2011). For similar reasons, high voltage direct current (HVDC) links do not contribute to system inertia (EirGrid & SONI 2010). Collectively, power sources such as wind turbines and HVDC links are called non-synchronous generation. System Non-Synchronous Penetration (SNSP) is a metric used to quantify the instantaneous power delivered from non-synchronous generation to the grid. Its defined in (O'Sullivan et al. 2014) as the ratio:

$$SNSP = \frac{P_{wind} + P_{HVDC(import)}}{P_{load} + P_{HVDC(export)}} \quad (2)$$

Currently, the Irish power system operates with a maximum SNSP limit of 50%, however, for Ireland to meet its 40% RES-E targets by 2020, this limit needs to be increased to 75% (EirGrid & SONI 2015a). This will result in a power system that operates with very low inertia during times of high wind penetration and could be susceptible to high RoCoF events should a grid disturbance occur. This has been demonstrated using computer model simulations of the 2020 Irish power system in (EirGrid & SONI 2010) and also using a generic power system model in (Dudurych & Conlon 2014).

Grid Code V6 specifies that generating units including wind farm power stations (WFPS);

“remain synchronised to the Transmission System during rate of change of Transmission System Frequency of values up to and including 0.5 Hz per second” (EirGrid 2015).

This means that synchronous generators are required to stay synchronised to the grid for RoCoF events up to 0.5 Hz/s, however, The Facilitation of Renewables Study (EirGrid & SONI 2010) found that following the loss of the largest generator on the 2020 Irish system, RoCoF values more than 0.5 Hz/s could be seen but not greater than 1 Hz/s. This could potentially result in the cascade tripping of some synchronous generators from the system (EirGrid & SONI 2012) or the operation of anti-islanding RoCoF relays on the distribution system. To combat this, EirGrid, the transmission system operator (TSO), has proposed to change the RoCoF standard to 1 Hz/s measured over a rolling window of 500 ms (EirGrid & SONI 2012). The Commission for Energy Regulation (CER) has approved this change to the Grid Code in principle, but will not give effect to the new standard in the Grid Code until it has received confirmation from EirGrid that enough generators can comply with the new standard to allow EirGrid to safely operate the system in a manner reliant on the new RoCoF standard (CER 2014).

The conventional generators in Ireland, i.e. the owners of the synchronous generator based power

plants, have expressed concern over the proposed change to the RoCoF standard. (CER 2014) summarises some of these concerns. They argue that there is considerable technical uncertainty as to whether conventional generation units will be capable of complying with the new standard. Concern is expressed over the time frame that the RoCoF is measured over. The modification proposes that conventional generator units must be able to withstand a RoCoF of 1 Hz/s measured over a rolling window of 500 ms. This is effectively the average RoCoF over that period, however, generator units see the actual instantaneous frequency and not the average, regardless of how the RoCoF is measured, and RoCoF values measured over shorter time periods could be much higher, resulting in units tripping, even though the average RoCoF measured over 500 ms was within the limit of 1 Hz/s. Conventional generators also express other concerns in (CER 2014), such as synchronous generators ability to stay synchronised to the grid or catastrophic failure during high RoCoF events and also concern is expressed over the impact high and more frequent RoCoF events will have on the commercial life of the plant.

Following on from the Facilitation of Renewables study, Studies on the Rate of Change of Frequency Events on the All-Ireland System (Temtem & Creighton n.d.) looked at two significant scenarios that were not investigated during the Facilitation of Renewables study; loss of the East-West Interconnector (EWIC) and loss of the Tandragee tie-lines resulting in system separation between Ireland and Northern Ireland. For the loss of the EWIC scenario, the study looked at the RoCoF at eight different buses throughout the island of Ireland. It calculated the RoCoF using both 500 ms and 100 ms rolling windows. The results showed large deviations between the magnitude of the RoCoF at each bus, ranging from a minimum of 0.23 Hz/s to a maximum of 2.71 Hz/s when measured over a 100 ms rolling window. The study commented on the local nature of RoCoF due to the fact that during transient conditions, generator rotor speeds may be different due to local and inter-area interactions. To achieve a more reliable measurement of the overall system wide RoCoF, the

study used a rolling window of 500 ms. With this longer rolling window there was very little deviation between the RoCoF at most of the buses, ranging from 0.41 Hz/s to 0.43 Hz/s, however, one bus had a significantly larger RoCoF of 0.53 Hz/s, 23% larger than the RoCoF at the other buses. The study also showed that when a 500 ms rolling window was used, the magnitude of the RoCoF measured is significantly smaller.

3 Methodology

To investigate the local nature of RoCoF, a model of the New England Power System, also known as the IEEE 39 bus power system, was implemented and simulated using the software package Power Systems Simulation for Engineers (PSS/E). The IEEE 39 bus test case consists of 10 generators, so the simulation was run 10 times. For each simulation, a disturbance was introduced onto the power system by disconnecting a different generator. Machine rotor speeds and bus frequencies were recorded over the simulated duration of 5 seconds. As PSS/E does not have the facility to calculate RoCoF, the bus frequency and machine speed data were exported to Matlab for analysis.

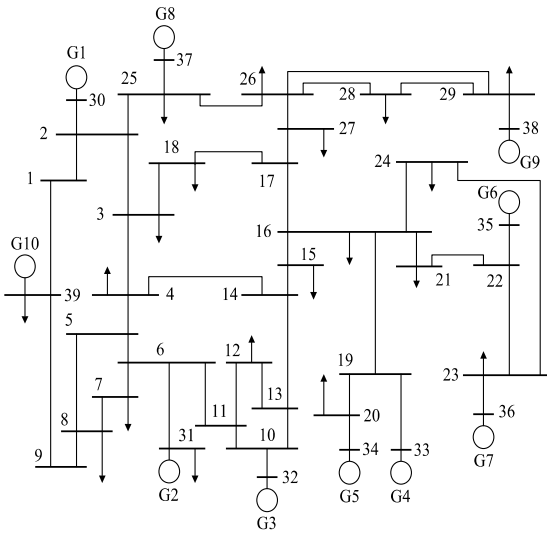

Figure 1 IEEE 39 bus power system, extracted from (Bakhtvar et al. 2016)

3.1 Predicted RoCoF

A common way of predicting the RoCoF of a power system after a disturbance is to use the centre of inertia defined in (Anderson & Fouad 2003). A variation of this is presented in slightly different

forms in (EirGrid & SONI 2015b) and (Dudurych & Conlon 2014) as:

$$\frac{df}{dt} = -\Delta P \frac{f}{2HS} \quad (3)$$

Where $\frac{df}{dt}$ is the initial RoCoF, ΔP is the change in power, f is the system rated frequency, H is the remaining inertia constant of the entire system after the disturbance and S is the rated power of the system. Equation (3) was used to predict the initial system RoCoF after each disturbance and the results were then compared to the initial system RoCoFs determined by the computer model and simulations.

3.2 Actual RoCoF Measurement

To investigate the effect of measuring the RoCoF over a rolling window, equation (4) was implemented with Matlab.

$$\frac{df}{dt}[n] = \frac{f[n] - f[n - N]}{NT} \quad (4)$$

Where $\frac{df}{dt}[n]$ is the RoCoF at sample n , $f[n]$ is the frequency at sample n , N is the number of samples in the moving average window and T is the duration of the moving average window. The RoCoF at several buses was calculate using (4) when the moving average window was equal the simulation time step of 0.003 seconds, i.e. the instantaneous RoCoF and the RoCoF was calculated when the moving average window was 0.5 seconds. The RoCoF calculated using both moving average window sizes were compared.

3.3 RoCoF Deviation between Buses

When a sudden disturbance occurs on an electrical power system a step change in output power occurs on the synchronous generators. Different generators will be impacted to a greater or lesser extent depending on factors such as the inertia of the machines, electrical distance to the disturbance and synchronizing power coefficient. During this transient period the rotors of the synchronous generators will accelerate or decelerate and oscillate at different rates depending on how each individual machine is impacted. This will produce deviations in the frequency and RoCoF observed at each bus in the system until the system settles to a new steady state condition. To quantify the deviation in bus

RoCoF, the relative standard deviation (*RSD*) was used, where the standard deviation (σ) and mean (μ) are defined as:

$$\sigma = \sqrt{\frac{1}{N_b} \sum_{i=1}^{N_b} \left| \frac{\Delta f}{\Delta t_i} - \mu \right|^2} \quad (5)$$

$$\mu = \frac{1}{N_b} \sum_{i=1}^{N_b} \frac{\Delta f}{\Delta t_i} \quad (6)$$

$$RSD = \frac{100 \times \sigma}{|\mu|} \quad (7)$$

Where N_b is the number of buses in the system and $\frac{\Delta f}{\Delta t_i}$ is the RoCoF observed at bus i .

3.4 Local RoCoF and System RoCoF

Immediately after a power system disturbance a deviation will exist in the frequency and RoCoF between all buses. This will produce local variations in frequency and RoCoF throughout the system. The term local will be used to describe the frequency and RoCoF observed at an actual bus. The term system will be used to describe the frequency and RoCoF across the entire power system. This is taken as the average of the frequency or RoCoF observed across all buses:

$$f_s[n] = \frac{1}{N_b} \sum_{i=1}^{N_b} f_i[n] \quad (8)$$

$$\frac{\Delta f}{\Delta t_s}[n] = \frac{1}{N_b} \sum_{i=1}^{N_b} \frac{\Delta f}{\Delta t_i}[n] \quad (9)$$

Where f_s and $\frac{\Delta f}{\Delta t_s}$ are system frequency and RoCoF respectively and N_b is the number of buses in the system.

3.5 RoCoF and RoCoRS

When simulating disturbances on electrical power systems using PSS/E, the dynamic frequency of each bus calculated by PSS/E may not be accurate at the instant and immediately after the disturbance. This is a problem especially when trying to calculate the

instantaneous RoCoF immediately after a disturbance.

According to (Radman & A Tabrizi 2012) an existing dynamic frequency calculation method is based on the derivative of angles of bus voltages and this can result in an unrealistic frequency for certain types of disturbances. This is because after a disturbance, the bus voltage phase angle may change instantly, resulting in a very large derivative. (Radman & A Tabrizi 2012) goes on to state that using the derivative of the voltage angle is the existing method used by PSS/E to calculate dynamic frequency and illustrates this with many examples of unrealistic dynamic frequencies immediately after short circuit faults.

The issue of simulating dynamic frequency after a grid disturbance is also thoroughly investigated in (Milano & Ortega 2016). The paper suggests that using the derivative of the bus voltage angle to calculate dynamic frequency is commonly used in proprietary software tools for power systems simulation. This supports the statement in (Radman & A Tabrizi 2012), that PSS/E uses the derivative of the bus voltage to calculate dynamic frequency. (Milano & Ortega 2016) goes into greater detail on how dynamic frequency is calculated based on the derivative of the bus voltage angle. It demonstrates a method where a wash-out filter is used to approximate the derivative of the bus voltage angle. The derivative is then filtered using a low-pass filter.

To explore how PSS/E calculates dynamic frequency, a simple simulation of a three-bus system with a disturbance was run. The bus voltage angles and the dynamic bus frequency were recorded. The bus voltage angles were exported to Matlab and the rate of change of the bus voltage angles was calculated. The results were compared to the dynamic frequency of the same bus calculated by PSS/E. The dynamic frequency resulting from both methods can be seen in figure 2.

The dynamic frequency based on the rate of change of bus voltage angle is almost the same as the dynamic frequency calculated by PSS/E, except a spurious spike can be seen in the frequency based on the derivative of the bus voltage angle. This spurious spike is not present in the frequency calculated

directly by PSS/E, however, it appears to be slightly distorted where the spurious spike would have been.

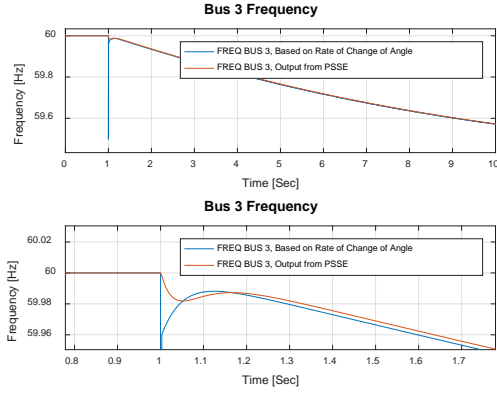

Figure 2 Dynamic bus frequency calculated by PSS/E and dynamic bus frequency calculated based on the derivative of the bus voltage angle for the same bus.

This distortion suggests that PSS/E calculates dynamic frequency based on the derivative of the voltage angle and removes any spurious spikes using a low-pass filter. This observation supports the arguments made in (Radman & A Tabrizi 2012) and (Milano & Ortega 2016). As the filtering action is not perfect it produces a distortion in the dynamic frequency immediately after the disturbance. Calculating the RoCoF immediately after a disturbance based on this distorted dynamic frequency could lead to an incorrect and excessively large RoCoF being calculated.

PSS/E uses the swing equation to calculate generator rotor acceleration after disturbances, given in (Anon 2015) as;

$$2H \frac{dn}{dt} = \frac{P_{mech} - D_e n}{1 + n} \quad (10)$$

Where H is the inertia constant of the generator, n is the per unit speed deviation of the generator rotor, P_{mech} is the rotor mechanical power given by $(P_{mech})_{nominal\ speed} - D_t n$, D_t is the turbine speed damping and D_e is the damping effect due to the speed sensitivity of the electrical loads in the power system.

This is a well-established and reliable method used in numerous text books on power system dynamics, such as (Anderson & Fouad 2003) and (Kundur et al. 1994). To explore this further, the dynamic speed of the generator rotor from the simple three bus

simulation was compared to the dynamic frequency at the same bus and are illustrated in figure 3. The distortion in the bus frequency is clearly visible but not present in the machine rotor speed, and as the rotational speed of the generator rotor determines the frequency of the bus voltage, this would indicate that the distortion in the bus frequency cannot be due to an oscillation in the rotor speed. This further supports the argument that the dynamic frequency calculated by PSS/E immediately after a disturbance is not reliable.

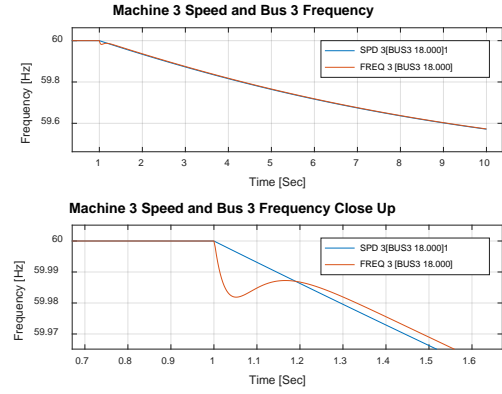

Figure 3 Dynamic bus frequency calculated by PSS/E and dynamic generator speed for the generator connected to the same bus.

Figure 4 shows the RoCoF based on the dynamic frequency calculated by PSS/E and the rate of change of rotor speed (RoCoRS) based on the dynamic speed of the generator rotor connected to the same bus. It can be clearly seen that the RoCoF calculated based on the dynamic bus frequency is far greater than the RoCoRS seen at the machine. This indicates that the RoCoF calculated at the bus is not reliable as it should be the same as the RoCoRS.

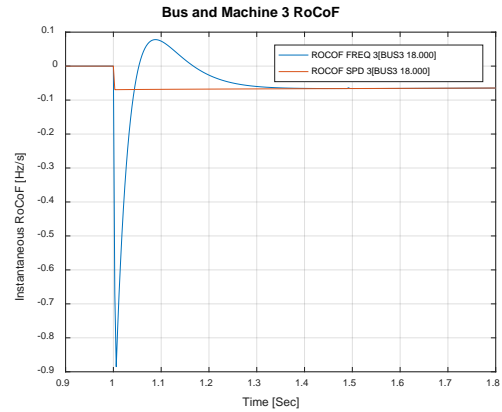

Figure 4 RoCoF based on dynamic frequency calculated by PSS/E and RoCoRS of generator connected to the same bus. Both should be the equal.

Because of the possibility of inaccurate results associated with calculating dynamic bus frequency immediately after a disturbance and since the frequency of a generator bus should be the same as the rotational frequency of the generator rotor, it was decided to use the RoCoRS as a more reliable indication of the local and system frequency and RoCoF immediately after the disturbances. However, the disadvantage of this assumption is that the results are limited to the generator buses only, the local dynamic frequency and RoCoF of non-generator buses has not been calculated.

3.6 Electrical Distance

To investigate how the magnitude of the RoCoRS varies with electrical distance from the disturbance, the electrical distance from each generator to all other generators was calculated using the Thevenin impedance between the generator buses, defined in (Cuffe & Keane 2015) as:

$$Z_{ij}^{thev} = Z_{ii} + Z_{jj} - Z_{ij} - Z_{ji} \quad (11)$$

Where Z_{ij}^{thev} is the Thevenin impedance between buses i and j , Z_{ii} and Z_{jj} are the i^{th} and j^{th} diagonal elements of the system Zbus matrix and Z_{ij} and Z_{ji} are the corresponding off diagonal elements of the system Zbus matrix.

4 Results and Discussion

Figures 5-12 show the results of one of the simulations. Machine number 8 was tripped at a time of 1 second. Figure 5 shows the change in rotor speeds for the remaining 9 machines following the disturbance. It can be seen that all machines begin to decelerate, some at a different rates than others. The machine rotors also oscillate around the predicted initial speed change, again some more than others. It is obvious that machine G1 has been impacted the most and will have the largest RoCoRS.

Figure 6 shows the machine RoCoRS following the disturbance. Most machines have an initial RoCoRS approximately equal to the predicted initial RoCoF of -0.19 Hz/s, however, machine G1 has an initial RoCoRS approximately 26 times greater than the predicted initial RoCoRS.

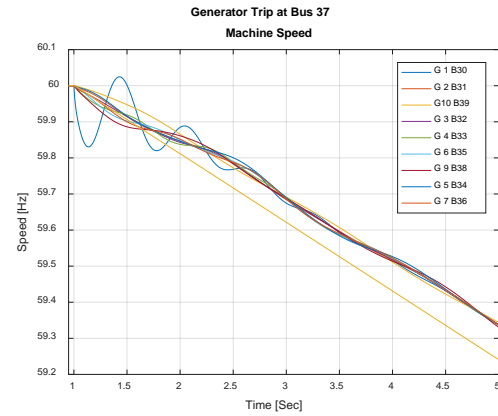

Figure 5 Generator rotor speeds after disturbance.

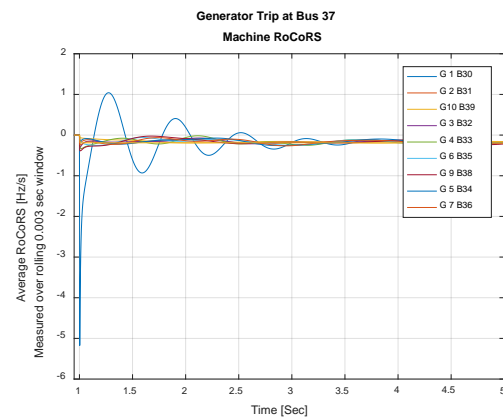

Figure 6 Generator RoCoRS after disturbance.

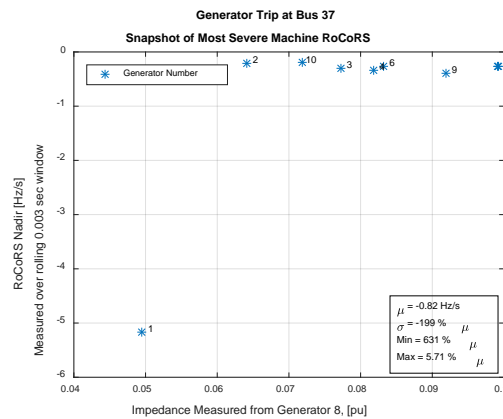

Figure 7 Snapshot of most severe RoCoRS seen at each generator.

Figure 7 shows a snapshot of the most severe RoCoRS recorded at each machine. It also shows the electrical distance, measured in per unit impedance, from each machine to the machine that was tripped, i.e. the location of the disturbance. It clearly shows that the machine electrically closest to the disturbance was impacted the most and this machine seen the worst RoCoRS. It can also be seen that the

relative standard deviation, expressed as a percentage of the mean RoCoRS, is 199%. The worst RoCoRS, seen at machine G1, expressed as a percentage of the mean RoCoRS, is 631%.

Figures 10 and 11 show the average of the machine speeds and RoCoRS following the disturbance, i.e. the system frequency and RoCoF. The initial system RoCoF is not as extreme as the local RoCoRS at machine G1, however, it is still significantly larger than the predicted initial RoCoF.

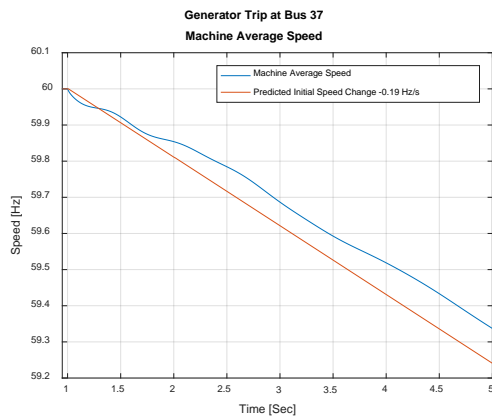

Figure 10 Average of machine speeds, i.e. system frequency.

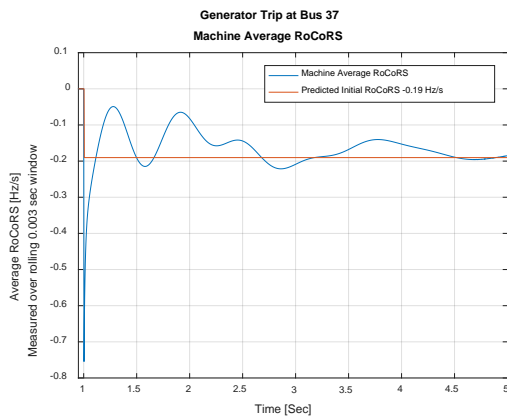

Figure 11 Average of machine RoCoRS, i.e. system RoCoF.

Figures 8, 9 and 12 show the results of the same simulation except a rolling average window of 0.5 seconds was used to calculate the RoCoRS.

Figures 8 and 9 show the machine RoCoRS following the disturbance. Comparing these to figures 5 and 6, it can be seen that by using a moving average window of 0.5 seconds, the magnitude of the RoCoRS measured has been reduced. The RoCoRS for each machine is now closer to the predicted RoCoRS, however, the local RoCoRS at

machine G1 is still larger than the predicted RoCoF by approximately 78%.

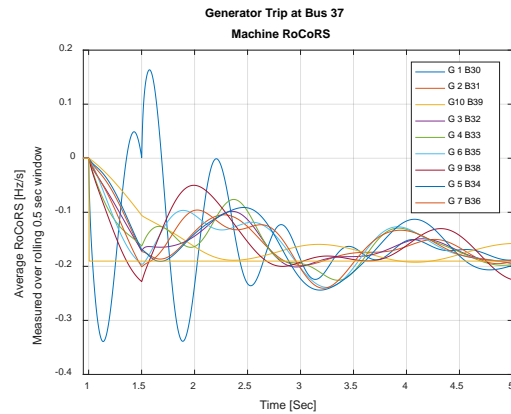

Figure 9 RoCoRS after disturbance measured with a moving average window of 0.5 seconds.

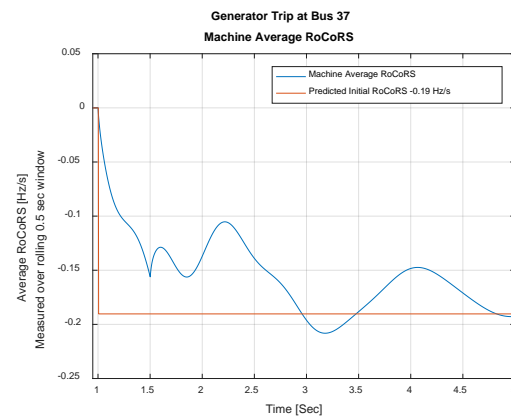

Figure 8 Average of machine RoCoRS after disturbance, i.e. system RoCoF, measured with a moving average window of 0.5 seconds.

Figure 12 shows a snapshot of the most severe local RoCoRS recorded at each machine as measured over the 0.5 second rolling window. The worst local RoCoRS is still recorded at the machine closest to the disturbance with a magnitude 45% larger than the mean of the worst local RoCoRS and 78% larger than the predicted system RoCoF. Also, the measured relative standard deviation has been reduced from 199% to 18.7%.

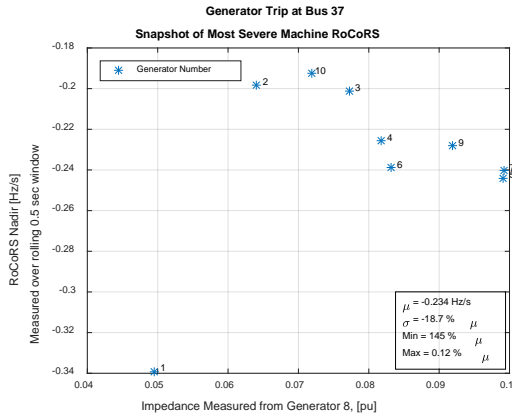

Figure 12 Snapshot of most severe RoCoRS measured with a moving average window of 0.5 seconds.

Table 1 and 2 show a summary of the results for the tripping of generator 8. Tables 3 and 4 show the results for all the simulations measured using a moving average windows of 0.5 seconds.

Table 1 Summary of system values for tripping of G8

| Rolling Window | Predicted System RoCoF | Actual System RoCoF | Percentage Error |
|----------------|------------------------|---------------------|------------------|
| (s) | (Hz/s) | (Hz/s) | (%) |
| 0.003 | -0.19 | -0.75 | 292% |
| 0.5 | -0.19 | -0.21 | 9.3% |

Table 2 Summary of local values for tripping of G8

| Rolling Window | Mean Local RoCoRS | Deviation Local RoCoRS | Maximum Local RoCoRS |
|----------------|-------------------|------------------------|----------------------|
| (s) | (Hz/s) | (% Mean) | (% Mean) |
| 0.003 | -0.81 | 198% | 629% |
| 0.5 | -0.23 | 19% | 145% |

It can be seen in Table 3 that the predicted RoCoF is close to the actual measured RoCoF for the majority of the simulations, except for simulations 7 and 10. This would indicate that using the centre of inertia to calculate system RoCoF is reasonably accurate provided the RoCoF is calculated over a moving average window of 0.5 seconds, however, simulations 7 and 10 would require further investigation to determine why there is such a difference between the predicted and measured values.

It can also be seen in Table 4 that the maximum local RoCoRS can be significantly larger than the average of the local RoCoRS. The maximum local RoCoRS seen ranged from 20% to 45% bigger than the mean of the local RoCoRS. This suggests, as seen in all cases considered, a significant local RoCoRS occurs when a disturbance occurs on an electric power system, even when the RoCoRS is measured over a 0.5 second rolling window.

Table 3 Results of system values for all simulations, measured over a rolling average window of 0.5 seconds.

| Tripped Machine | Predicted System RoCoF | Actual System RoCoF | Percentage Error |
|-----------------|------------------------|---------------------|------------------|
| | (Hz/s) | (Hz/s) | (%) |
| 1 | -0.078 | -0.075 | -4% |
| 2 | -0.202 | -0.204 | 0.6% |
| 3 | -0.231 | -0.191 | -18% |
| 4 | -0.225 | -0.220 | -2% |
| 5 | -0.180 | -0.215 | 19% |
| 6 | -0.233 | -0.265 | 14% |
| 7 | -0.198 | -0.285 | 44% |
| 8 | -0.190 | -0.208 | 9% |
| 9 | -0.305 | -0.289 | -5% |
| 10 | -0.817 | -0.575 | -30% |

Table 4 Results of local values for all simulations, measured over a rolling average window of 0.5 seconds.

| Tripped Machine | Mean Local RoCoRS | Deviation Local RoCoRS | Maximum Local RoCoRS |
|-----------------|-------------------|------------------------|----------------------|
| | (Hz/s) | (% Mean) | (% Mean) |
| 1 | -0.09 | 14% | 134% |
| 2 | -0.21 | 10% | 119% |
| 3 | -0.21 | 10% | 121% |
| 4 | -0.27 | 20% | 142% |
| 5 | -0.28 | 23% | 137% |
| 6 | -0.32 | 21% | 138% |
| 7 | -0.36 | 27% | 140% |
| 8 | -0.23 | 19% | 145% |
| 9 | -0.34 | 14% | 132% |
| 10 | -0.64 | 10% | 122% |

5 Conclusion

The results show that using the centre of inertia to predict local RoCoF magnitudes or instantaneous system wide RoCoF magnitudes is not reliable, and is only suitable for predicting system-wide RoCoF levels averaged over a time period using a rolling window.

The simulations have also shown that when a large disturbance occurs on a power system, such as the loss of a generator, all remaining generators will be impacted to a greater or lesser extent. The generator closest to the disturbance will experience the greatest RoCoRS, possibly many times greater than the system average RoCoF and the predicted RoCoF.

When the RoCoF is measured over a moving average window of 0.5 seconds, the effect is to reduce the measured RoCoF and relative standard deviation, reducing measured variations between local RoCoRS. However, these simulations showed that local RoCoRS could still be significantly larger than the mean of the RoCoRS and predicted system wide RoCoF. A situation could occur where a disturbance on a power system results in a relatively small system RoCoF; however, a local RoCoRS close to the disturbance could be significantly larger. This could result in operation of the machine's protective devices, catastrophic failure or incremental wear and tear leading to premature failure of the machine. In the event of catastrophic failure or operation of the machine's protective devices, a cascading event could be triggered resulting in other generators disconnecting and complete shutdown of the electrical power system.

As inertia decrease on electrical power systems due to increased wind power penetration, power system operators will need to operate these systems within tighter limits. These systems must be designed and operated in such a way as to ensure that following a large disturbance, not only is the average system RoCoF below the limits of the system, but local RoCoFs are also below the limits. Power system operators need to operate power systems so that the average system RoCoF resulting from a disturbance is well below limits to ensure larger local RoCoFs do not breach limits.

6 References

- Anderson, P.M. & Fouad, A.A., 2003. *Power System Control and Stability* 2nd ed., John Wiley & Sons.
- Bakhtvar, M. et al., 2016. Synchronizing Torque Impacts on Rotor Speed in Power Systems. *IEEE Transactions on Power Systems*, (99), pp.1–1.
- CER, 2014. *Rate of Change of Frequency (RoCoF) Modification to the Grid Code*,
- Cuffe, P. & Keane, A., 2015. Visualizing the Electrical Structure of Power Systems. *IEEE Systems Journal*, pp.1–12.
- Dudurych, O. & Conlon, M., 2014. Impact of reduced system inertia as a result of higher penetration levels of wind generation. In *Power Engineering Conference (UPEC), 2014 49th International Universities*. IEEE, pp. 1–6.
- EirGrid, 2015. *EirGrid Grid Code* 6 ed., Available at: <http://www.eirgridgroup.com/site-files/library/EirGrid/GridCodeVersion6.pdf>.
- EirGrid & SONI, 2010. *All Ireland TSO Facilitation of Renewables Studies*,
- EirGrid & SONI, 2015a. *Delivering a Secure, Sustainable Electricity System (DS3) Programme Overview - 2015*,
- EirGrid & SONI, 2015b. *RoCoF Alternative & Complementary Solutions Project*, Eirgrid, SONI. Available at: <http://www.eirgridgroup.com/site-files/library/EirGrid/RoCoF-Alternative-Complementary-Solutions-Project-Phase-2-Report.pdf>.
- EirGrid & SONI, 2012. RoCoF Modification Proposal. *soni.ltd.uk*. Available at: <http://www.soni.ltd.uk/media/documents/Archive/RoCoF%20Modification%20Proposal%20TSOs%20Opinion.pdf> [Accessed June 29, 2016].
- Kundur, P., Balu, N.J. & Lauby, M.G., 1994. *Power System Stability and Control*, McGraw-Hill Professional.
- Milano, F. & Ortega, A., 2016. Frequency Divider. *faraday1.ucd.ie*. Available at: <http://faraday1.ucd.ie/archive/papers/freqdiv.pdf> [Accessed July 14, 2016].
- Muljadi, E. et al., 2012. Understanding inertial and

- frequency response of wind power plants. In Power Electronics and Machines in Wind Applications (PEMWA), 2012 IEEE. IEEE, pp. 1–8.
- O'Sullivan, J. et al., 2014. Studying the Maximum Instantaneous Non-Synchronous Generation in an Island System - Frequency Stability Challenges in Ireland. *IEEE Transactions on Power Systems*, 29(6), pp.2943–2951.
- Radman, G. & A Tabrizi, M., 2012. Calculation of Power System Dynamic Frequency during Simulation Phase. *International Journal of Emerging Electric Power Systems*, 13(5).
- Ruttledge, L. & Flynn, D., 2011. System-wide inertial response from fixed speed and variable speed wind turbines. *Energy Society General Meeting*, pp.1–7.
- Scheer, J., Clancy, M. & Gaffney, F., 2016. *Ireland's Energy Targets, Progress, Ambition and Impacts*
- Temtem, S. & Creighton, K., Summary of Studies on Rate of Change of frequency Events on the all-Island System. *eirgrid.com*. Available at: <http://www.eirgrid.com/operations/ds3/technicalstudies/> [Accessed October 14, 2015].