



2010-09-01

# Wavelet Based Islanding Detection of DC-AC Inverter Interfaced DG Systems

Mohamed Moin Hanif

*Dublin Institute of Technology, mohamed.hanif@dit.ie*

Malabika Basu

*Dublin Institute of Technology, mbasu@ieee.org*

Kevin Gaughan

*Dublin Institute of Technology, Kevin.Gaughan@dit.ie*

Follow this and additional works at: <http://arrow.dit.ie/engscheleart>

 Part of the [Controls and Control Theory Commons](#), [Electrical and Electronics Commons](#), [Power and Energy Commons](#), and the [Signal Processing Commons](#)

## Recommended Citation

M. Hanif, U.D Dwivedi, M. Basu and K. Gaughan, "Wavelet Based Islanding Detection of DC-AC Inverter Interfaced DG Systems", UPEC 2010

This Conference Paper is brought to you for free and open access by the School of Electrical and Electronic Engineering at ARROW@DIT. It has been accepted for inclusion in Conference papers by an authorized administrator of ARROW@DIT. For more information, please contact [yvonne.desmond@dit.ie](mailto:yvonne.desmond@dit.ie), [arrow.admin@dit.ie](mailto:arrow.admin@dit.ie), [brian.widdis@dit.ie](mailto:brian.widdis@dit.ie).



This work is licensed under a [Creative Commons Attribution-Noncommercial-Share Alike 3.0 License](#)



# Wavelet Based Islanding Detection of DC-AC Inverter Interfaced DG Systems

M.Hanif  
Department of Electrical  
Engineering Systems  
Dublin Institute of  
Technology  
Kevin Street, Dublin 8,  
Ireland

mohamed.hanif@dit.ie

U.D Dwivedi  
Department of Electrical  
Engineering Systems  
Dublin Institute of  
Technology  
Kevin Street, Dublin 8,  
Ireland

dwivedi.umakant@gmail.com

M.Basu  
Department of Electrical  
Engineering Systems  
Dublin Institute of  
Technology  
Kevin Street, Dublin 8,  
Ireland

mbasu@ieee.org

K. Gaughan  
Department of Electrical  
Engineering Systems  
Dublin Institute of  
Technology  
Kevin Street, Dublin 8,  
Ireland

kevin.gaughan@dit.ie

**Abstract-** The increased penetration of distributed generation (DG) often connected to grid through dc-ac interface has made islanding detection an important and challenging issue to power engineers. Several methods based on passive and active detection scheme have been proposed in the literature. While passive schemes have a large non detection zone (NDZ), concern has been raised on active method due to its degrading power quality effect. This paper proposes a wavelet based passive islanding detection scheme with almost zero NDZ for dc-ac inverter interfaced grid connected DGs. The key idea is to utilize the spectral changes in the higher frequency components of PCC voltage occurring after islanding condition. The effectiveness of the proposed method is tested through case studies on a photovoltaic DG system.

**Index Terms**—Distributed generation, islanding detection, non detection zone, wavelet transform.

## I. INTRODUCTION

Islanding of grid-connected DG inverters (DC-AC) occurs when the local network containing such inverter is disconnected from the main utility, but the DG inverter continue energizing the local load without control and/or supervision of utility as shown in Fig. 1. This phenomenon can result in a number of potential hazards and therefore needs to be detected and protected from islanding. Basic passive protection schemes include over current, over- and under-voltage protection, and over- and under-frequency protection (OVP/UVP and OFP/UFP) functions to remove a grid-connected DG systems from the utility grid for the abnormal condition in the grid. Also, anti-islanding schemes must be incorporated into protection control. The above protection schemes are able to detect islanding operation of the grid connected DG systems when a large mismatch of power between the source and load is present, at the instance the grid disappears [1-3].

Generally, the power mismatches are large ( $\Delta P > 20\%$  or  $\Delta Q > 5\%$ ), causing the voltage or frequency to go out of the nominal range detecting Islanding scenario. But, if the mismatch is quite small leaving the voltage and frequency within the nominal range, the islanding detection becomes almost impossible using normal passive techniques,

producing a large non detection zone (NDZ). Also, if the threshold range is set small, nuisance tripping could occur. Therefore, passive detection methods on its own are not sufficient for anti islanding protection hence, at least one active anti-islanding scheme must be included in protection (to eliminate NDZ).

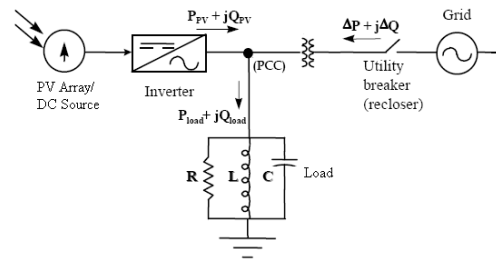

Fig.1. A typical Grid connected photo voltaic DG system

Active islanding scheme usually injects certain signals (perturbation to variables like voltage and frequency) in order to detect the islanding situation which degrades the output power quality [1]. EN50438 [3] provides requirements relevant to performance, operation, safety consideration, testing and maintenance of interconnection. Summary of essential interconnection specifications and requirements is given in Table 1. According to table 1, any active islanding technique that involves injections are not allowed. In response to the above mentioned detection problems and requirements specified by EN50438, a new technique is proposed to build an anti-islanding scheme [1-3].

Passive methods do have a NDZ and active methods reduce the NDZ close to zero but making a compromise with the output power quality. The main emphasis of the proposed scheme is to reduce the NDZ to as close as possible to zero and to keep the output power quality unchanged. The new method for islanding detection is based on the voltage measurements that are sensed at PCC and its analysis using discrete wavelet transform. This new method will help to

reduce the NDZ without any perturbation that deteriorates the output power quality.

TABLE I  
MICRO-GENERATION INTERFACE SETTINGS FOR REPUBLIC OF IRELAND [3]

Parameter	Trip setting	Clearance time
Over voltage	230 V + 10 %	0,5 s
Under voltage	230 V - 10 %	0,5 s
Over frequency	50 Hz + 1 %	0,5 s
Under frequency	50 Hz - 4 %	0,5 s
An explicit Loss of Mains functionality must be included. Established methods such as, but not limited to, Rate of Change of Frequency, Vector Shift or Source Impedance Measurement may be used. Where Source Impedance is measured, this must be achieved by purely passive means. Any implementation which involves the injection of pulses onto the DSO network, shall not be permitted.		
ROCOF [where used]	0,4 Hz/s	0,5 s
Vector Shift [where used]	6 degrees	0,5 s

## II. POWER MISMATCH DURING ISLANDING SCENARIO

The frequency of the system at islanding,  $\omega_i$ , is a function of the inverter real power  $P_{PV}$ , reactive power  $Q_{PV}$  and resonant frequency of the load ( $1/\sqrt{LC}$ ) according to [1-3].

$$\omega_i \approx \frac{1}{\sqrt{LC}} \left( 1 + \frac{Q_{PV}}{2qP_{PV}} \right). \quad (1)$$

The inverter terminal voltage  $V_i$  at the instant utility is disconnected, is a function of the ratio of real power of the PV inverter and the load as expressed below.

$$V_i = \sqrt{\left( \frac{P_{PV}}{P_{Load}} \right)} V_n, \quad (2)$$

where,  $V_n$  is nominal system voltage. The worst case islanding condition occurs when the real power of the PV inverter is equal to the real power of the load i.e.,  $P_{PV} = P_{Load}$ , and the corresponding reactive power is also equal i.e.,  $Q_{PV} = Q_{Load}$ . For this condition, the voltage and the frequency at the inverter terminal continues to be the same as when utility was connected. Under this condition, the PV inverter fails to notice the disconnection of utility and continues to operate, hence, causing islanding. When the above described conditions are nearly met, the variations in the voltage and the frequency may be small and may escape the detection. This zone is called a non-detection zone. Some islanding scenarios are examined [1-3]:

**When  $\Delta P$  is large:** Inverter terminal voltage will vary widely and since voltage should be outside the nominal operating voltage range for detection, islanding condition can be detected effectively only if  $\Delta P > \pm 20\%$ .

**When  $\Delta P$  is small &  $\Delta Q$  is large:** Islanding frequency will vary and the frequency has to go out of nominal limit to be detected. For islanding protection, the inverter will fail to disconnect when the load has  $q \geq 2.5$ ,  $\Delta P = 0$ , and  $\Delta Q < \pm 5\%$ .

**When  $\Delta P$  &  $\Delta Q$  are small:** if  $\Delta P (< \pm 20\%)$  and  $\Delta Q (< \pm 5\%)$  then this results in insufficient change in inverter

terminal voltage and frequency respectively, which falls within the non-detection zone as shown in the Fig. 2.

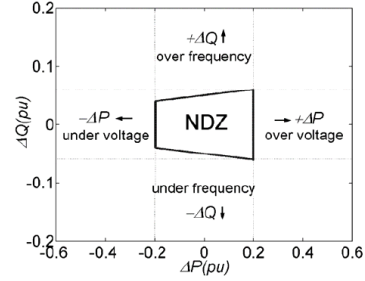

Fig. 2. NDZ for UVP/OVP and OFP/UFP

## III. WAVELET TRANSFORM

Wavelets are functions, used to efficiently describe a signal by decomposing it into its constituents at different frequency bands (or scales) [4]. Wavelet technique has been used in several power system applications e.g. detection, feature extraction, de-noising and data compression of power quality waveforms, power system protection etc. [5-7]. Wavelet theory is very well documented in several research publications related to power engineering applications and hence, only a brief explanation of wavelet theory relevant to islanding application is provided in this section.

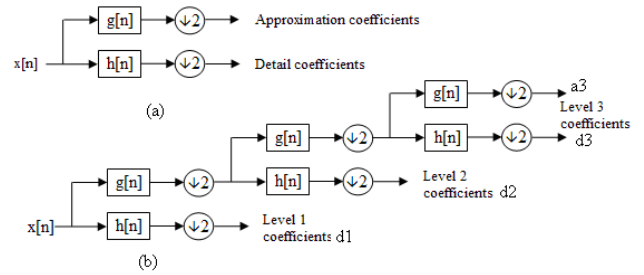

Fig. 3 (a) Analysis wavelet filter banks (b) 3-stage DWT decomposition

Discrete wavelet transform (DWT) based on Mallat's pyramid algorithm [8], also known as dyadic wavelet transform is the most frequently used method owing to its simplicity and non-redundancy. A dyadic DWT of discrete time sequence  $x(n)$  of length  $N$  is essentially a decomposition of the spectrum of  $x(n)$ ;  $X(\omega)$  into orthogonal sub-bands defined by,

$$\frac{1}{2^{m+1}T} \leq \omega \leq \frac{1}{2^m T}, \quad m = 1, 2, \dots, J \quad (3)$$

where,  $T$  is the sampling period associated with  $x(n)$  and  $J$  represents the total number of decomposition levels. DWT is implemented by specially designed bank of high pass and low pass discrete filter units,  $h$  and  $g$ . The filters are half band filters with a cutoff frequency of  $F_s / 4$ , a quarter of the input sampling frequency. As the input sequence  $x(n)$  propagates through the low pass and high pass filters, the filter bank, at each stage, decomposes the signal into low-pass and high-

pass components through convolution (and subsequent decimation) with filters  $g$  and  $h$ , respectively. The DWT representation is composed of scaling coefficients,  $c_j(n)$ , representing coarse or low-pass signal information at level  $m = J$ , and wavelet coefficients (also called detail coefficients),  $d_m(n)$ , which represents signal detail at levels  $m = 1, \dots, J$ , as shown in Fig.3. Formally,

$$\begin{aligned} c_m(n) &= \sum_n g(2n-k)c_{m-1}(k) \\ d_m(n) &= \sum_n h(2n-k)c_{m-1}(k). \end{aligned} \quad (4)$$

At level  $m$ , both  $c_m(n)$  and  $d_m(n)$  are composed of  $2^{-m} N$  coefficients, forming a tree-like relationship between the coefficients at successive scales. The resulting signal decomposition  $[d_1, d_2, \dots, d_J, c_J]$  is the dyadic DWT representation of signal  $x(n)$ .

#### IV. PROPOSED ALGORITHM

To resolve the problem of non-detection zone associated with passive islanding detection methods, wavelet analysis is proposed and included with passive technique in this paper. The key idea is to utilize the spectral changes in the higher frequency components of PCC voltage during islanding. When islanding takes place under NDZ condition, conventional passive methods which are based on threshold violations of certain PCC voltage and frequency parameters, fail to recognize it as these parameters are well within the threshold limit. Whereas, use of wavelet technique additionally facilitates to examine the spectral changes occurring at higher frequency components of PCC voltage due to islanding, thus enabling the islanding detection in the NDZ even without injecting any signal. In the proposed method, three phase PCC voltage signals are decomposed up to a chosen decomposition level  $J$  using dyadic DWT signal decomposition and analysis method described in the previous section.

Considering  $V_a(t)$ ,  $V_b(t)$  and  $V_c(t)$  which are the time domain signal measurements' at PCC, and  $[d_{a1}, d_{a2}, \dots, d_{aJ}, c_{aJ}]$ ,  $[d_{b1}, d_{b2}, \dots, d_{bJ}, c_{bJ}]$  and  $[d_{c1}, d_{c2}, \dots, d_{cJ}, c_{cJ}]$  the resulting DWT decomposition outputs. Where  $d_{ak}$ ,  $d_{bk}$  and  $d_{ck}$  are respectively the set of wavelet coefficients corresponding to strength of  $V_a(t)$ ,  $V_b(t)$  and  $V_c(t)$  at the  $k^{\text{th}}$  frequency wavelet band. An initially study was carried out for a Grid connected PV system on Simulink using wavelet and its result is show in Fig. 4. In this preliminary study, islanding scenario is created at 0.31s with matched load and it is found that the drift in the PCC voltage is not sufficient to reach the threshold limit of UVP/OVP detector. As shown in the Fig. 4, the wavelet coefficients at higher frequency band details (i.e.,  $d_{a1}, d_{a2}, d_{a3}, d_{a4}$ ), show large changes after islanding, which can be used for islanding detection by choosing appropriate threshold settings for wavelet coefficients.

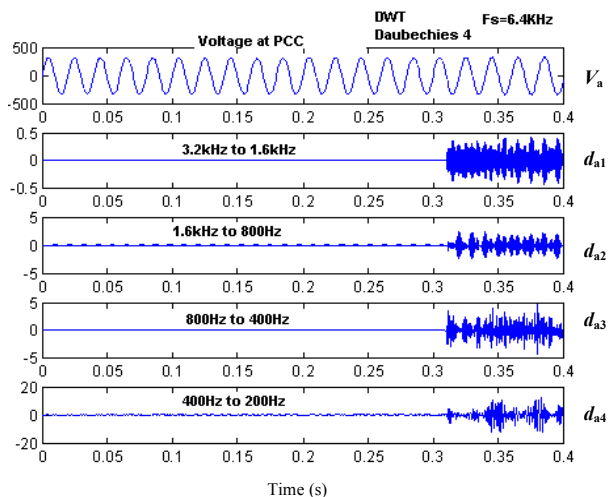

Fig. 4. Four stage DWT decomposition of PCC phase voltage  $V_a$

But, appropriate measure should be taken to avoid nuisance tripping due to occurrence of any transient disturbance or noise during normal operation of the system, which may produce sufficient higher magnitude wavelet coefficients at these frequency bands. Hence, use of a simple threshold setting based on wavelet coefficients' magnitude would be risky and may lead to many nuisance tripping scenarios. From extensive simulations, second level wavelet coefficients ( $d_2$ ) are found to be more robust, as these are least affected by the noise (which is more dominant at level 1) and common power system disturbances and harmonics-variations (due to variation in nonlinear load etc.) mostly occupying third and other lower frequency bands. Therefore, energy of the wavelet coefficients at second decomposition level calculated once in every two cycle, has been proposed. Three energy values namely  $E_a$ ,  $E_b$ , and  $E_c$  (per two cycles) of second level wavelet coefficients corresponding to three phase PCC voltages are calculated as

$$E_p = \sqrt{\left[ \sum_{i=1}^{i=L} \text{abs}(d_{p1}(i)) / L \right]}, \quad (5)$$

where,  $p \in \{a, b, c\}$  and,  $L$  is the number of coefficients per two power cycles. Islanding is detected when one or more of these calculated energy parameters becomes greater than a set threshold.

#### V. SIMULATION AND RESULTS

To test the performance of the proposed wavelet based islanding scheme a grid connected PV system, shown in the Fig. 5, has been simulated on Matlab/Simulink platform. The PV system is operated using maximum power point tracking (MPPT) scheme and is interfaced to the grid using a three phase pulse width modulated full-bridge dc-ac inverter.

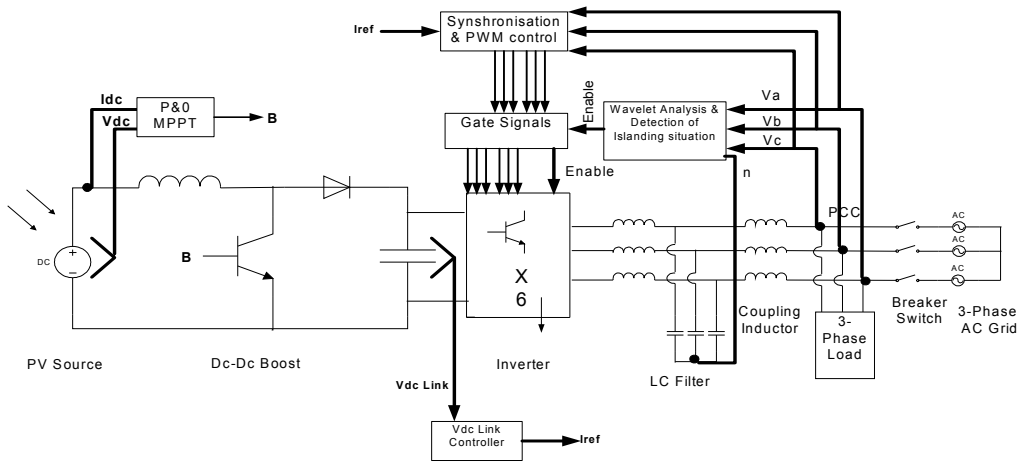

Fig. 5. System diagram for simulation

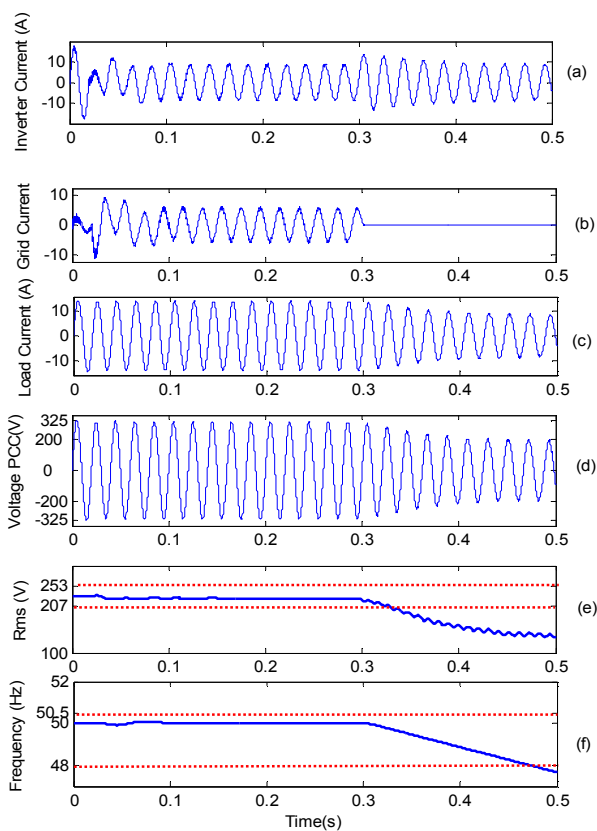

Fig. 6. Case of large power mismatch with passive method

The PV inverter used can supply a maximum load of 4.2kW. The power transferred to grid changes with change in local load power demand. The power frequency of the simulated system is 50Hz and PCC voltage measurements are converted to per unit values before these are processed through the wavelet islanding detection block. Daubechies “db4” mother wavelet [4], has been used because of its compactness, and localization properties.

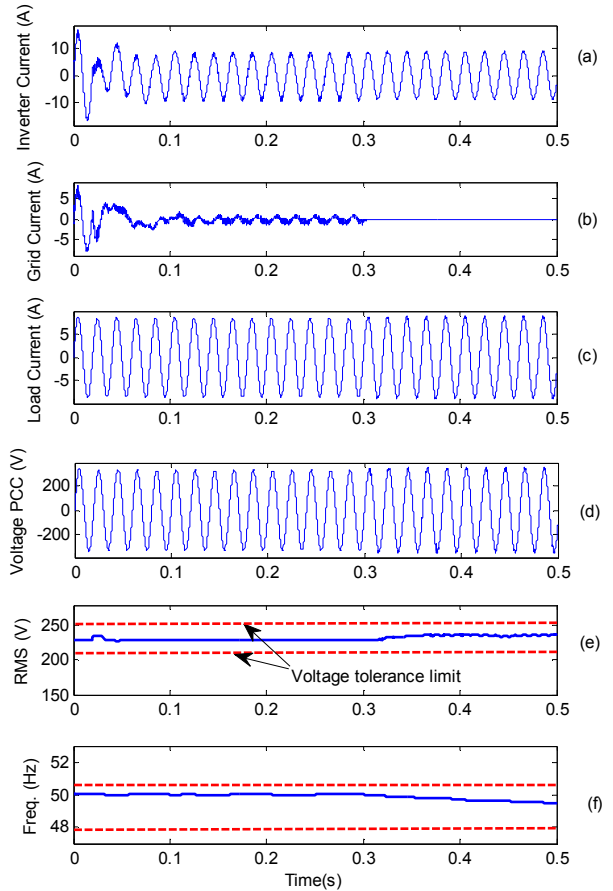

Fig. 7. Case of “close to zero” power mismatch (NDZ) with passive method

Different islanding scenarios (islanding with large power mismatch, close to zero power mismatch NDZ etc.) have been created using the three phase breaker circuit and by changing the power demand of local load connected to the system. During normal operating condition, the wavelet islanding detection block generates a constant inverter enable

signal of value '1' and upon detecting islanding the value of the enable signal is changed to '0' thus halting the inverter operation.

Since, the PV inverter is forced to operate at unity power factor, only active mismatch of power is considered. For the first case study islanding is created at 0.3 seconds with large power mismatch condition (i.e.  $\Delta P > \pm 20\%$ ). The local load demand in this case is 7kW out of which 4.2kW is supplied by the PV inverter and rest by the grid. For brevity, results for only one phase are shown in Fig. 6. A large power mismatch due to islanding causes the voltage at PCC drifting away from the nominal operating range within two cycles as shown in the Fig. 6(e), thus enabling the OVP/UVF relays detect the islanding condition easily. In the second case, islanding is created with 'close to zero' power mismatches (i.e. in NDZ) where, the local power demand is 4.2kW as shown in Fig. 7. It can be seen from Figs. 7(e)-(f) that after islanding (at 0.3s) the PCC voltage and frequency remains within the operating range. Thus, confirming that the passive methods based on the OVP/UVF and OFP/UFV relays fail to detect islanding under such conditions.

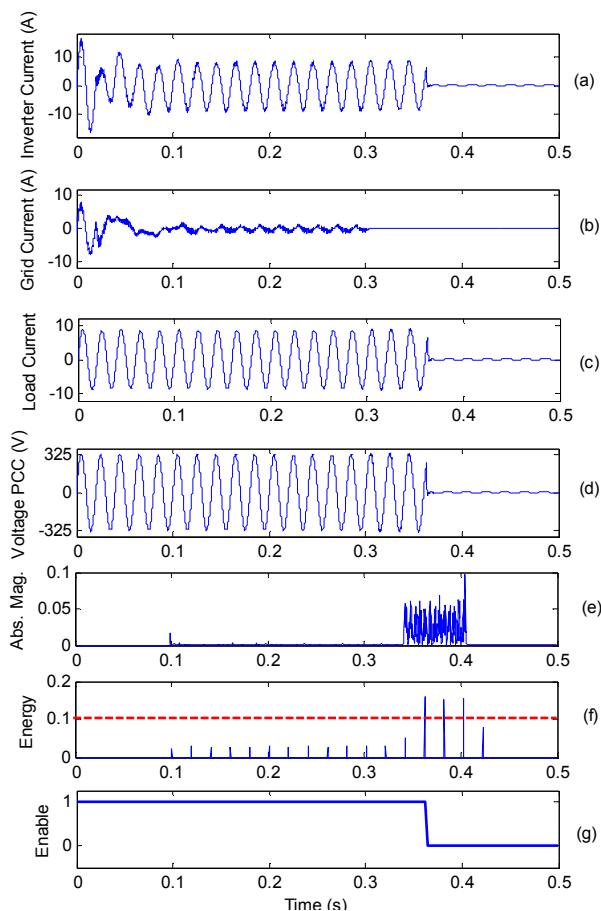

Fig. 8. Case of "close to zero" power mismatch (NDZ) with wavelet-based detection scheme

This 'close to zero' power mismatch islanding scenario is also tested using the proposed wavelet based method as

shown in Fig. 8. Depicted in figures 8(e) and 8(f) are the second level wavelet coefficients (absolute values) and corresponding energy values calculated as per equation (5). It can be observed from the figure that there is a large change both in the magnitudes of wavelet coefficients and in calculated energy values after islanding event. Therefore, the inverter enable signal which was set to '1' ( for normal operation) is forced to '0' by the wavelet detection module once the energy value crosses the set threshold (0.1) finally, ceasing the inverter operation and power delivery to the load. The response time of the proposed method is found to be around 2.5 cycles which is fast enough as per the standards.

## VI. CONCLUSION

The islanding situation needs to be prevented with distributed generation due to safety reasons and to maintain quality of power supplied to the customers. Large mismatch of power shows the voltage at PCC drifting away from the nominal operating range within few cycles but "close to zero" mismatch of power shows the voltage within the nominal range, making it difficult to be detected by OVP/UVF and OFP/UFV relays in a passive environment. The proposed scheme operates on the PCC voltage measurement and is able to detect the islanding condition within 2.5 power frequency cycles. To avoid the nuisance tripping due to transient disturbances, which may result if wavelet coefficient thresholds are used directly, a new parameter namely energy values of second level wavelet coefficients are proposed to detect the islanding condition. The results presented clearly demonstrate the effectiveness of the proposed islanding detection scheme even under the worst case scenario i.e. 'close to zero' power mismatch condition.

## REFERENCES

- [1] W. Bower and M. Ropp, "Evaluation of Islanding Detection Methods for Photovoltaic Utility-Interactive Power Systems," *Tech Rep. IEA PVPS T5-09*, 2002, [Online] Available: <http://www.iea-pvps.org>, 2002
- [2] Ye Z.; et al, "Evaluation of Anti-Islanding Schemes based on Nondetection Zone Concept", *IEEE Trans. Power Electronics*, vol.19, no. 5, Sept 2004
- [3] EN50438, "Requirements for the connection of micro-generators in parallel with public low-voltage distribution networks", *European Committee for Electro technical Standardization*, December 2007.
- [4] U. D. Dwivedi, and S. N. Singh, "Enhanced Detection of Power Quality Events Using Intra and Inter-Scale Dependencies of Wavelet Coefficients", *IEEE Trans. Power Delivery* vol. 25, no. 1, pp. 358-366, Jan. 2010.
- [5] U. D. Dwivedi, and S. N. Singh, "De-noising Techniques with Change-Point Approach for Wavelet-Based Power Quality Monitoring" *IEEE Trans. on Power Delivery* vol. 24, no. 3, pp. 1719-1727, July 2009.
- [6] U. D. Dwivedi, S. N. Singh, and S. C. Srivastava, "A Wavelet based Approach for Classification and Location of Faults in Distribution Systems", *IEEE Conf. & Exhibition on Control, Communication and Automation (INDICON)*, India, vol. 2 pp. 488-493, Dec. 11-13, 2008.
- [7] J. Daubechies "The wavelet transforms, time frequency localization and signal analysis," *IEEE Trans. IT*, vol.36, no.5, pp. 961-1005, Sep. 1990.
- [8] S. Mallat, "A theory for multi-resolution signal decomposition the wavelet representation," *IEEE Trans. Pattern Analysis and Machine Intelligence*, vol. 11, no. 7, pp. 674-693, 1989.