



2009-01-01

Emitter-wrap-through Photovoltaic Dipole Antenna with Solar Concentrator

Maria Roo Ons

Dublin Institute of Technology

S. Shynu

Dublin Institute of Technology

Max Ammann

Dublin Institute of Technology, max.ammann@dit.ie

Sarah McCormack

Dublin Institute of Technology

Brian Norton

Dublin Institute of Technology

Follow this and additional works at: <http://arrow.dit.ie/engscheceart>



Part of the [Electrical and Computer Engineering Commons](#)

Recommended Citation

Ons, R., et al. (2009) Emitter-wrap-through photovoltaic dipole antenna with solar concentrator. *Electronics Letters*, February 26 2009, Vol.45, pp.241-242. doi:10.1049/el:20093617

This Article is brought to you for free and open access by the School of Electrical and Electronic Engineering at ARROW@DIT. It has been accepted for inclusion in Articles by an authorized administrator of ARROW@DIT. For more information, please contact yvonne.desmond@dit.ie, arrow.admin@dit.ie.



This work is licensed under a [Creative Commons Attribution-NonCommercial-Share Alike 3.0 License](#)



Emitter-wrap-through photovoltaic dipole antenna with solar concentrator

M.J. Roo Ons, S.V. Shynu, M.J. Ammann, S.J. McCormack and B. Norton

A novel photovoltaic dipole antenna employing a solar concentrator as a reflector is proposed. Four identical emitter-wrap-through rear contact solar cells connected in series as a folded dipole are simultaneously used for power generation and as the antenna radiating element, which is located in the focal line of a parabolic solar concentrator. The parabolic structure acts as a solar concentrator for the photovoltaic cells as well as a reflector for the folded dipole antenna. Full-wave electromagnetic simulation with supportive experimental work validates this design. The measured fractional impedance bandwidth and gain were 21% and 11.1 dBi, respectively. The antenna/solar arrangement provide a power output of 73.7 mW for an irradiance of 1000 Wm⁻².

Introduction: The combination of solar cells and radiating elements into a single device is very attractive in communication systems in order to save space and to reduce installation costs by increasing the potential of emerging compact technologies. It has been shown in space satellite applications that photovoltaic (PV) cells can be located close to microstrip antennas, avoiding the region where the effective electric fringing field exists [1]. The development of thin amorphous silicon technology on flexible polymer substrates enables solar cells to fit into complex antenna geometries, but with lower photovoltaic cell efficiency [2]. In recent years increased attention has been focused on the use of polycrystalline silicon solar cells. They have been used as radiating patches owing to their homogenous metallic rear contact, and also as a ground plane for microstrip antennas [3, 4].

A new approach in solar antenna design is proposed using a parabolic solar concentrator to increase the illuminated flux on the PV surface, thus reducing the amount of PV material required, and simultaneously acting as an antenna reflector. The electrically conductive emitter-wrap-through (EWT) solar cells are used as antenna elements, where the solar array is connected in series in the form of a folded dipole. A compact decoupling circuit at the dipole feed is used to separate the RF and DC currents.

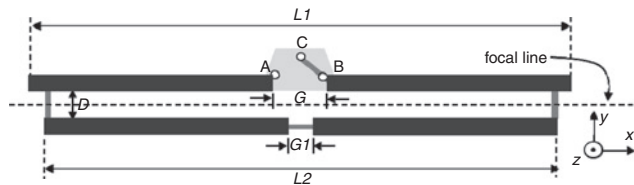

Fig. 1 Solar folded dipole with dimensions $L_1 = 85$ mm, $L_2 = 82$ mm, $D = 4$ mm, $G = 5$ mm, $G_1 = 2$ mm

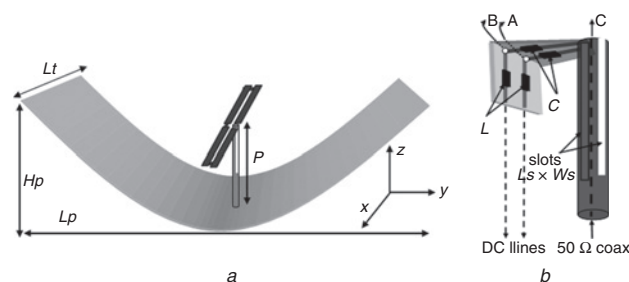

Fig. 2 Solar folded dipole antenna with parabolic reflector

a Perspective view of proposed antenna with dimensions $L_t = 205$ mm, $H_p = 75$ mm, $L_p = 245$ mm for parabolic reflector with focal line at $P = 55$ mm
b RF-DC decoupling network with dimensions $L_s = 45$ mm, $W_s = 1.9$ mm for slot illustrating balun on 50 Ω line

Use of EWT rear contact solar cell: Conventional crystalline and amorphous silicon solar cells used so far in solar antenna approaches have contact metallisation on both front and rear surfaces to extract current [5]. In the EWT, the front surface of the cells used is devoid of any metallisation so that the complete cell surface is available for light absorption [6]. Even though the emitter is located near the front, both negative and positive polarity contacts are placed on the rear surface

with the negative contact connected to the front through emitter wrapped holes. Consequently, for this type of cell there is no fully covered metallisation on any side, just an interdigitated structure alternating positive and negative polarity metal fingers. The RF behaviour was investigated at microwave frequencies and it was found to behave very closely to that of a conducting strip.

Antenna design: The proposed folded dipole consists of four identical 40×3 mm rear contact solar cells interconnected in series, as shown in Fig. 1. The dimensions of the folded dipole arms are $L_1 = 85$ mm and $L_2 = 82$ mm, with a feed gap of $G = 5$ mm. The spacing between the arms is $D = 4$ mm. The 300 Ω input impedance of the folded dipole is reduced to 200 Ω by the introduction of the parabolic solar concentrator (see Fig. 2a). A split-coaxial balun is implemented by introducing two identical slots of dimensions $L_s = 45$ mm and $W_s = 1.5$ mm on opposite sides of the outer conductor of the semi-rigid Flexiform 402 NM 50 Ω coaxial line, as shown in Fig. 2b. A 4:1 impedance transformation is achieved with this balun by adjusting the slot length [7].

Since the solar cells in the presented structure are working simultaneously as power sources and microwave radiating elements, a DC/RF decoupling circuit is necessary, which is integrated into the feed gap of the folded dipole solar antenna. A standard arrangement of chip capacitors and inductors ($C = 100$ pF, $L = 68$ nH) is used to isolate the DC and RF, as shown in Fig. 2b. The folded solar dipole antenna is then positioned along the focal line of the parabolic concentrator, with the active side of the cells facing the reflector. The DC connection and feedline pass through a 9 mm radius hole to the back of the reflector.

The design was optimised using a full-wave electromagnetic simulator, CST Microwave Studio. For a parabolic trace following the curve $z = 0.005y^2$, the vertical distance between the antenna and reflector for a 200 Ω input impedance at the dipole was found to be $P = 55$ mm. The required parabolic reflector dimensions are $L_t > 85$ mm and $H_p > 55$ mm for maximum light concentration, but the actual dimensions chosen were $L_t = 205$ mm and $H_p = 75$ mm to ensure a minimum gain of 10 dBi over the entire band. 3M Vikuiti™ Enhanced Specular Reflector Film was used as the conducting reflector surface. The advantage of selecting a folded dipole over an ordinary dipole is the fact that the series connection of solar cells provides additive DC voltages, as well as its broader bandwidth and convenient matching.

Results and discussion: The simulated and measured S_{11} of the proposed antenna is shown in Fig. 3 with good agreement. The measured return loss was found to be greater than 10 dB in the frequency range 1.35–1.68 GHz, which corresponds to a fractional impedance bandwidth of 21%. The measured and simulated E- and H- plane normalised radiation patterns for centre frequency are shown in Fig. 4. The measured gain at the centre frequency was found to be 11.1 dBi with little variation across the band. The front-to-back ratios for the E- and H- planes were better than 27 and 30 dB respectively. The measured cross-polar rejection is better than 20 dB for both planes.

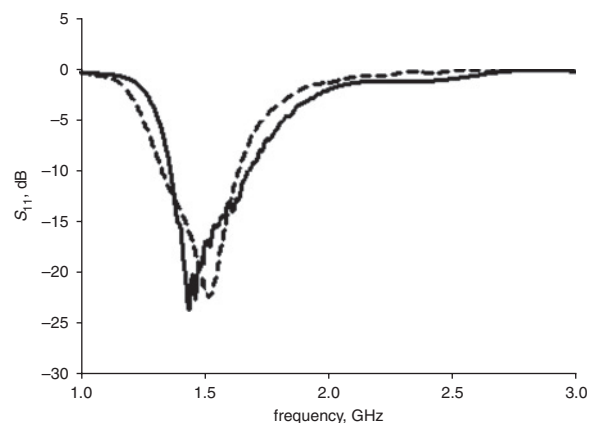

Fig. 3 Simulated and measured S_{11} plots for proposed EWT dipole antenna
 — measurement
 - - - simulation

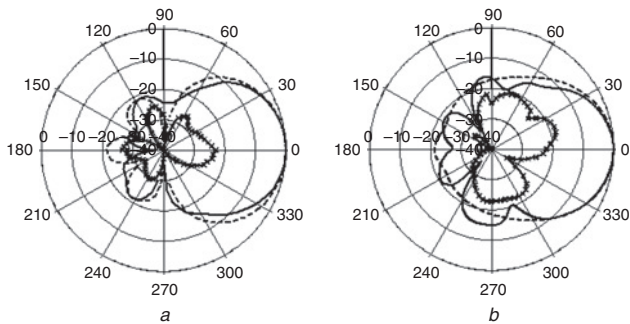

Fig. 4 Measured radiation patterns at 1.49 GHz

a E-plane (zx)
 — co-polar measurement
 - x - cross-polar measurement
 - - - - co-polar simulation
b H-plane (zy)
 — co-polar measurement
 - x - cross-polar measurement
 - - - - co-polar simulation

Single junction silicon solar cells provide approximately 0.5–0.6 V, independently of the cell size. The dipole comprising four cells in series realised a voltage of 2.22 V. The behaviour of the solar dipole as a power source was investigated by illumination with a Griven INSE 1200 MSR metal halide lamp continuous solar simulator. The solar cells face towards the parabolic reflector and a 10% increase in current was achieved where the dipole was placed at the concentrator focal line, in comparison to the standalone dipole directly facing the light. The four cell solar dipole supplies 73.7 mW ($I = 33.2$ mA, $V = 2.22$ V) at an irradiance of 1000 Wm^{-2} for the reflector with 3M Vikuiti ESR film.

Conclusions: A novel folded dipole comprising EWT rear contact solar cells with a parabolic solar concentrator reflector is proposed. The full integration of solar cells and antenna in one device where the PV cells act as the RF radiating element is demonstrated. A maximum antenna gain of 11.1 dBi is achieved over a 21% bandwidth. The parabolic

reflector works simultaneously as an antenna reflector and as a solar concentrator increasing the current output by 10%.

Acknowledgment: This work was supported by Science Foundation Ireland (SFI) and the research support unit of DIT.

© The Institution of Engineering and Technology 2009
 17 December 2008

Electronics Letters online no: 20093617
 doi: 10.1049/el:20093617

M.J. Roo Ons, S.V. Shynu and M.J. Ammann (*School of Electronic and Communications Engineering, Dublin Institute of Technology, Kevin Street, Dublin 8, Ireland*)

E-mail: mariajose.rooons@student.dit.ie

S.J. McCormack and B. Norton (*Dublin Energy Lab, Focas Institute, Camden Row, Dublin 8, Ireland*)

References

- 1 Tanaka, M., Suzuki, Y., Araki, K., and Suzuki, R.: 'Microstrip antennas with solar cells for microsattellites', *Electron. Lett.*, 1996, **31**, pp. 263–266
- 2 Vaccaro, S., Mosig, J.R., and De Maagt, P.: 'Two advanced solar antenna SOLANT designs for satellite and terrestrial communications', *IEEE Trans. Antennas Propag.*, 2000, **AP-51**, (8), pp. 2028–2034
- 3 Bendel, C., Henze, N., Weitz, M., Hofmann, P., and Kirchoff, J.: 'Investigations on planar antennas with photovoltaic solar cells for mobile communications'. IEEE Int. Symp. on Personal, Indoor and Mobile Radio Communication (PIMRC), 2004, Vol. 1, pp. 622–626
- 4 Shynu, S.V., Roo Ons, M.J., Ammann, M.J., McCormack, S.J., and Norton, B.: 'Inset-fed microstrip patch antenna with integrated polycrystalline photovoltaic solar cell'. Second European Conf. on Antennas and Propagation (EuCAP), Edinburgh, UK, November 2007
- 5 Lasnier, F., and Gan Ang, T.: 'Photovoltaic engineering handbook' (CRC Press, 1990)
- 6 Van Kerschaver, G., and Beaucarne, G.: 'Back-contact solar cells: a review', *Prog. Photovolt.: Res. Appl.*, 2006, **14**, pp. 107–123
- 7 Makarov, R., and Ludwig, R.: 'Analytical model of the split-coaxial balun and its application to a linearly polarized dipole or a CP turnstile', *IEEE Trans. Antennas Propag.*, 2007, **AP-55**, (7), pp. 1909–1918