



2007-01-01

High Quality Millimeter Wave Generation via Stimulated Brillouin Scattering

Marcus Junker

Deutsche Telekom Fachhochschule Leipzig

Thomas Schneider

Deutsche Telekom Fachhochschule Leipzig

Kai-Uwe Lauterbach

Deutsche

Ronny Henker

Deutsche Telekom Fachhochschule Leipzig

Max Ammann

Dublin Institute of Technology, max.ammann@dit.ie

See next page for additional authors

Follow this and additional works at: <http://arrow.dit.ie/engschececon>

 Part of the [Electrical and Computer Engineering Commons](#)

Recommended Citation

Junker, M. et al. 92007) High quality millimeter wave generation via stimulated Brillouin scattering. CLEO 2007: *Conference on Lasers and Electro-Optics*, pp.1-2. Baltimore, 6-11 May, 2007, doi:10.1109/CLEO.2007.4452356

This Conference Paper is brought to you for free and open access by the School of Electrical and Electronic Engineering at ARROW@DIT. It has been accepted for inclusion in Conference papers by an authorized administrator of ARROW@DIT. For more information, please contact yvonne.desmond@dit.ie, arrow.admin@dit.ie.



This work is licensed under a [Creative Commons Attribution-NonCommercial-Share Alike 3.0 License](#)



Authors

Marcus Junker, Thomas Schneider, Kai-Uwe Lauterbach, Ronny Henker, Max Ammann, and Andreas Schwarzbacher

High Quality Millimeter Wave Generation via Stimulated Brillouin Scattering

Markus Junker, Thomas Schneider, Kai-Uwe Lauterbach, Ronny Henker

*Deutsche Telekom AG, Fachhochschule Leipzig, Gustav-Freytag Straße 43-45, 02477 Leipzig, Germany
E-Mail: junker@fh-telekom-leipzig.de*

Max J. Ammann, Andreas T. Schwarzbacher

School of Electronic & Communications Engineering, Dublin Institute of Technology, Dublin, Ireland

Abstract: A new and simple method for the generation and modulation of Millimeter waves is presented. Based on frequency upconversion via Stimulated Brillouin Scattering, it is very flexible in its output frequency and modulation bandwidth.

©2007 Optical Society of America

OCIS codes: (190.4370) Nonlinear optics, fibers; (290.5900) Scattering, stimulated Brillouin

1. Introduction

The growing demand for wireless gigabit networks has strongly affected the research interests of new transmission systems. Recently, a 10 Gbit/s wireless transmission link at 125 GHz verified the great potential of millimeter wave (mm-waves) photonics [1], as a prospective field of investigation.

Several optical generation techniques of mm-waves have been verified in the past. Ref. [2] and [3] reflect only a small excerpt. Most of them are based on the heterodyning of two phase correlated frequency components in a photo detector. Besides a high level of complexity and sensitivity to environmental influences, a high frequency microwave synthesizer is required limit these techniques. However, the application of Stimulated Brillouin Scattering (SBS) as a narrow band amplifier offered new opportunities in the field of mm-wave generation [3]. SBS occurs even at low power levels and has low phase noise properties [5][6]. On the other hand the gain bandwidth lies in the range of approximately 35 MHz for Standard Single Mode Fibers (SSMF) and limits its applicability [7].

In this paper we demonstrate a new and simple mm-wave generation method that requires neither a synthesizer higher than 9.8 GHz nor other unconventional optical components. For modulation processes it is independent of the SBS gain bandwidth. The method is based on the superposition between the modulated carrier and a sideband amplified by SBS.

2. Experiment

The half of the light of a fiber laser (Signal Laser: line width <1 kHz, wavelength ~1550.12 nm, power: 24 mW) is modulated by a Mach-Zehnder modulator (MZM). The MZM is driven by a 9.8 GHz continuous wave source in the lower quadratic operation mode to realize double sideband suppressed carrier modulation. A high modulation power (35.5 dBm) applied to the MZM generates sidebands up to the order of 6. This frequency comb is launched into a 50 km Standard Single Mode Fiber (SSMF) via a 3 dB coupler. The other 50% of the signal laser light is amplified by an Erbium Doped Fiber Amplifier to a power level of 12 dBm and is sent into the same SSMF as one can see in Fig. 1.

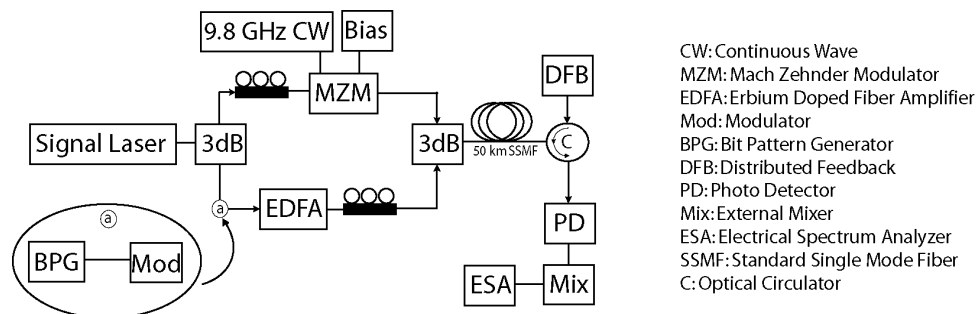

Fig. 1. Experimental set up of the Millimeter wave generator. Inset (a): A possible modulation implementation

The pump wave (power: 5.5 mW) of a Distributed Feedback laser diode generates a backward scattered Brillouin gain that is downshifted in frequency. The pump system is driven under the Brillouin threshold. The gain frequency is adjusted in such a manner that the Brillouin gain amplifies one sideband of the frequency comb. In this paper we show a 27.1 dB amplification of the 5th harmonic. The two phase correlated frequency components (optical carrier and the amplified sideband) are coupled out via an optical circulator (see Fig. 2 (left)) and are heterodyned in a 110 GHz photo detector (PD). The output current of the PD follows the fading frequency between the two components which is 49 GHz in our setup. Carrier modulation can be applied very simply by adding an adequate modulator into the set up as demonstrated in Fig. 1 (inset a). The idea of modulating the optical carrier and hence the modulation of the mm-wave was given by Park [8]. Since we modulate the carrier which is not affected by SBS we see no limitation concerning the modulation bandwidth, neither due to a narrow Brillouin bandwidth nor to any other restrictions.

3. Results

Spectrum measurements of a 49 GHz Lorentzian shaped millimeter wave carrier can be seen in Fig. 2 (right). The optical input power of the PD is -1.05 dBm. As one can see in Fig. 2 (right) the carrier has a signal-to-noise ratio of 70 dB, a 3 dB bandwidth of approximately 500 Hz and a magnitude of -34.1 dBm. Due to the natural attenuation in the fiber all other optical sidebands are decreased in their magnitude, which avoids additional electrical frequency components at the output of the PD. Of course, by using other frequency comb generation methods such as phase modulation, for instance, sidebands of higher orders and hence higher frequencies can be generated. A power fluctuation of ± 0.8 dB and a frequency fluctuation of ± 75 mHz over a 6 h time frame was observed. Preliminary phase noise measurements let us expect a value of -95 dBc/Hz at 10 kHz offset from the carrier.

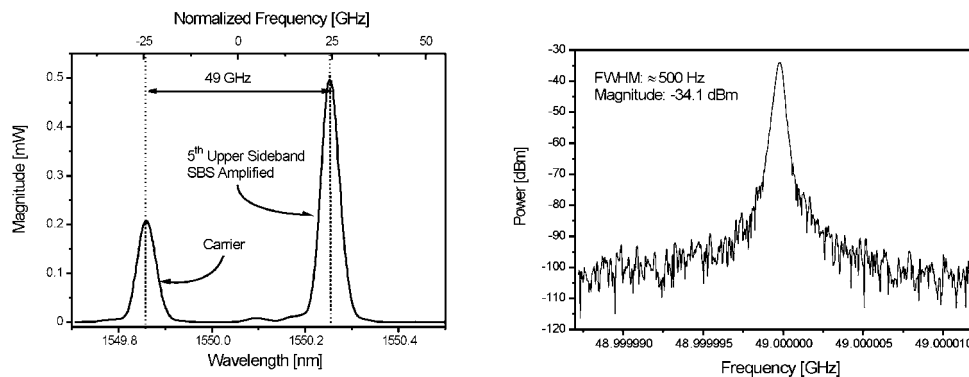

Fig. 2. Left: Optical spectrum at the circulator output; Right: Spectral analysis of the 49 GHz carrier signal

4. Summary

In this paper a new and simple method for the mm-wave generation and its modulation is verified. The maximum achievable frequency depends only on the bandwidth of the photo detector. Carrier modulation can be simply implemented into the setup and, to our knowledge, there is no obvious limitation to the modulation bandwidth.

5. References

- [1] A. Hirata, T. Kosugi, H. Takahashi, R. Yamaguchi, F. Nakajima, et. al., "120-GHz-Band Millimeter-Wave Photonic Wireless Link for 10-Gb/s Data Transmission," *IEEE TMTT* **54**, 1937-1944 (2006).
- [2] D. Wake, C. R. Lima, P. A. Davis, "Optical generation of millimetre-wave signals for fiber-radio systems using a dual mode DFB semiconductor laser," *IEEE TMTT* **43**, 2270-2276 (1996).
- [3] U. Gliese, T. N. Nielsen, M. Bruun, et. al., "A wideband heterodyne optical phase locked loop for generation of 3-18 GHz microwave carriers," *IEEE Phot. Techn. Lett.* **4**, 936-938, (1992).
- [4] X. S. Yao, "Brillouin Selective Sideband Amplification of Microwave Photonic Signals," *IEEE Phot. Techn. Lett.* **10**, 138-140 (1998).
- [5] M. Junker, M. J. Ammann, A. T. Schwarzbacher, J. Klinger, K.-U. Lauterbach, Th. Schneider, "A Comparative Test of Brillouin Amplification and Erbium Doped Fiber Amplification for the Generation of Millimeter Waves with Low Phase Noise Properties," *IEEE TMTT* **54**, 1576-1581 (2006).
- [6] Th. Schneider, M. Junker, K.-U. Lauterbach, "Theoretical and experimental investigation of Brillouin scattering for the generation of millimeter waves," *JOSA B* **23**, 1012-1019, (2006).
- [7] T. Schneider, *Nonlinear Optics in Telecommunications*, (Springer-Verlag, Berlin Heidelberg New York, 2004), pp. 267-296.
- [8] C.S. Park, Personal Communication.